

Model 2018E

Conflict Monitor

Firmware Version 01-07-01

Operations Manual

Caltrans TEES-2002 Conflict Monitor Unit

This manual contains technical information for the
Model 2018E Conflict Monitor

pn 889-3809-01 Revision: April 2020



THE FOLLOWING PRODUCT WAS DESIGNED, INSPECTED, TESTED AND
MANUFACTURED IN THE USA BY EBERLE DESIGN, INC. IN PHOENIX, ARIZONA.
INFORMATION CONTAINED HEREIN IS PROPRIETARY TECHNICAL INFORMATION OF
EBERLE DESIGN, INC. PUBLICATION, REPRODUCTION OR USE IN WHOLE OR PART IS
NOT PERMITTED EXCEPT UNDER TERMS AGREED UPON IN WRITING. ALL
REGISTERED TRADEMARKS OF EBERLE DESIGN INC. ARE UNDER
© COPYRIGHT

MAINTENANCE NOTE

**IT IS AN EBERLE DESIGN, INC. RECOMMENDATION THAT EACH UNIT BE TESTED
AT LEAST ANNUALLY TO ENSURE COMPLIANCE WITH FACTORY
SPECIFICATIONS AND MEETS PROPER OPERATIONAL STANDARDS. THE
RESULTS OF THIS TESTING WILL BE DOCUMENTED.**

Model 2018E Operations Manual

Table of Contents

Section 1 General Description	1
Section 2 General Characteristics	3
2.1 Inputs	3
2.1.1 AC Line (AC +).....	3
2.1.2 AC Neutral (AC -).....	3
2.1.3 Earth Ground	3
2.1.4 Field Terminals (Reds, Yellows, and Greens).....	3
2.1.5 Red Enable.....	4
2.1.6 Special Function Inputs.....	4
2.1.7 MC Coil Input	4
2.1.8 DC Ground.....	4
2.1.9 +24 VDC Input	4
2.1.10 Watchdog Timer Input.....	4
2.1.11 External Reset Input.....	5
2.1.12 Cabinet Interlock.....	5
2.2 Outputs	5
2.2.1 Output Relay.....	5
2.2.2 Stop Timing Output	5
2.3 Programming Card.....	5
2.3.1 Channel Compatibility (Permissives).....	5
2.3.2 Yellow Disable	5
2.4 Features.....	6
2.4.1 Monitor Power Up / Power Recovery.....	6
2.4.2 Monitor Power Failure.....	6
2.4.3 Reset	6
2.4.4 COM Port.....	7
2.4.5 Ethernet Port.....	7
2.4.6 Temperature Sensor	7
2.4.7 Real Time Clock.....	7
2.4.8 Up Time Accumulator.....	7
2.4.9 Configuration Monitoring (Beeping Monitor)	7
2.4.10 Factory Settings.....	8
2.4.11 User Unit Information	8
2.5 Fault Monitoring	8
2.5.1 Conflict Monitoring	8
2.5.2 Red Fail Monitoring.....	8
2.5.3 Daul Indication Monitoring.....	9
2.5.4 Short Yellow Monitoring	10
2.5.5 Short Clearance Monitoring.....	11
2.5.6 +24 Volts DC Monitoring	12
2.5.7 Watchdog Monitoring	12
2.5.8 Programming Card Absent Monitoring	12
2.6 Operation Modifiers.....	13
2.6.1 Option Switches.....	13
2.6.1.1 Option Switch 1 – Flashing Don't Walk Monitoring – DW MON	13
2.6.1.2 Option Switch 2 – Flashing Yellow Arrow Monitoring – FYA EN	13
2.6.1.3 Option Switch 3 - +24VDC Enhanced Monitoring – 24V ENH	14
2.6.1.4 Option Switch 4 – Special Function 1 Invert – SF1 INV.....	14
2.6.1.5 Option Switch 5 – Special Function 2 Invert – SF2 INV.....	15
2.6.1.6 Option Switch 6 – Green / Yellow Monitoring – GY MON	15
2.6.1.7 Option Switch 7 – 2010 Mode - 2010	15

2.6.1.8 Option Switch 8 – LED Thresholds – LED THR.....	16
2.6.2 Option Jumpers.....	16
2.6.2.1 Option Jumper 1 – Do Not Allow 16 Channel Program Card – NO CH1616	
2.6.2.2 Option Jumper 2 – Do Not Allow 18 Channel Program Card – NO CH1816	
2.6.2.3 Option Jumper 3 – Red Enable Must Be Active – RED EN	17
2.6.2.4 Option Jumper 4 – Multi Indication & Short Yellow Monitoring – MI/SY ON.....	17
2.6.3 Factory Options.....	17
2.6.3.1 Green Flash (Canadian Fast Flash)	17
2.6.3.2 Fast Start Up	17
2.6.3.3 Low AC Power Thresholds.....	18
2.6.3.4 Diagnostic LCD.....	18
2.6.4 Software Options	18
2.6.4.1 Log Field Changes.....	18
2.6.4.2 FYA for Channels 1-4 Use Yellow Drivers (FYA 1-4 Uses Yel).....	18
2.6.4.3 FYA for Channels 5-18 Use Yellow Drivers (FYA 5-18 Uses Yel).....	19
2.6.4.4 Flashing Yellow Arrow Ignores Yellow Conflict (FYA Ignores YEL Conflict)	20
2.6.4.5 Special Function 2 Enable	20
2.6.4.6 Force Watchdog to 1500 Milliseconds (Force WD 1500 mSec).....	20
2.6.4.7 Disable Buzzer	21
2.6.4.8 Daylight Savings Time	21
2.7 Event Logging	21
2.7.1 Time Change Log	21
2.7.2 Monitor Reset Log.....	21
2.7.3 Configuration Event Log.....	21
2.7.4 Prior Faults Log.....	21
2.7.5 AC Line Log.....	21
2.7.6 Signal Sequence Log.....	22
2.8 Diagnostics	22
2.8.1 Memory.....	22
2.8.2 Microprocessor Monitor.....	22
2.8.3 Internal Voltage Monitors	22
2.8.4 LED Display Test	22
2.8.5 Diagnostic Codes.....	23
Section 3 Specifications	24
3.1 Physical.....	24
3.2 Electrical	24
3.3 Timing Functions.....	24
3.4 Table: Rear Edge Connector Pin Assignments.....	26
3.5 Table: Front Panel Connectors Pin Assignments.....	27
3.6 Table: Programming Card Pin Assignments	28
Section 4 User Interface.....	29
4.1 Printed Circuit Board Switches & Jumpers	30
4.1.1 Dual Indication Enable Switches	30
4.1.2 Red Fail Switches	30
4.1.3 Option Switches	30
4.1.3.1 Switch 1 – Flashing Don't Walk Monitoring (DW MON).....	30
4.1.3.2 Switch 2 – Flashing Yellow Arrow Enable (FYA EN)	30
4.1.3.3 Switch 3 - +24VDC Enhanced Monitoring (24v enh)	31
4.1.3.4 Switch 4 – Special Function 1 Invert (SF1 INV).....	31
4.1.3.5 Switch 5 – Special Function 2 Invert (sf2 inv).....	31
4.1.3.6 Switch 6 – GY-Dual Indication Monitoring (GY MON).....	31
4.1.3.7 Switch 7 – 2010 Mode – 2010.....	31
4.1.3.8 Switch 8 – LED Thresholds (LED THR)	31
4.1.4 Option Jumpers.....	31
4.1.4.1 Jumper 1 – Do Not Allow 16 Channel Program Card (NO 16CH).....	31

4.1.4.2 Jumper 2 – Do Not Allow 18 Channel Programm Card (NO 18CH)	31
4.1.4.3 Jumper 3 – Red Enable Must Be ON (RED EN).....	32
4.1.4.4 Jumper 4 – Multiple Indication & Short Yellow Monitoring are Always ON (MI/SY ON).....	32
4.1.5 Watchdog Switch	32
4.2 Front Panel LED Indicators	32
4.2.1 Field Status Indicators.....	32
4.2.2 AC Power Indicator	32
4.2.3 VDC FAILED Indicator	33
4.2.4 WDT ERROR Indicator	33
4.2.5 CONFLICT Indicator	33
4.2.6 RED FAIL Indicator	33
4.2.7 MULTI IND Indicator	33
4.2.8 YELLOW Indicator	33
4.2.9 PC AJAR Indicator	33
4.2.10 DIAG FAIL Indicator	33
4.2.11 COMM Indicator.....	33
4.2.12 Function Disabled Indication	34
4.3 Audible Buzzer.....	34
4.3.1 Critical Failure	34
4.3.2 Configuration Change	34
4.4 Diagnostic Display Mode	34
4.4.1 AC Line Voltage	36
4.4.2 Configuration Display 1	36
4.4.2.1 Permissive Displays.....	36
4.4.3 Configuration Display 2	37
4.4.3.1 Flashing Yellow Arrow Displays	37
4.4.4 Prior Faults	38
Section 5 Firmware Upgrade	39

Section 1 General Description

This product manual is for people installing, operating, and maintaining the Reno A & E Model 2018E Conflict Monitor Unit (CMU). We designed the Reno A & E Model 2018E monitor to meet or exceed the specifications in Chapter 3, Section 6, of the Caltrans Transportation Electrical Equipment Specifications (TEES) dated 08/16/02. Section 6 responds to the need for a monitor to accomplish the detection of, and response to, improper and conflicting signals and improper operating voltages in a Controller Assembly (CA). This standard provides interchangeability between units of different manufacturers. We developed this eighteen-channel monitor to allow users to take full advantage of all eighteen load switch positions in a Model 332 cabinet with three output files. This monitor is backward compatible with sixteen-channel monitors.

The Model 2018E detects the presence of voltage on conflicting field connection terminals; it detects the absence of proper voltages on all of the signal field connection terminals of a channel, and it monitors for the presence of satisfactory operating voltages within the Controller Unit (CU) and the Model 2018E itself. If any of these conditions exist or are out of tolerance for the minimum time defined in Chapter 3 Section 6 of the Caltrans Transportation Electrical Equipment Specifications (TEES) dated 08/16/02, the Output relay's normally open contacts will transfer from the no fault state (relay energized) to the fault state (relay de-energized). The closure of the Output relay contacts will cause the transfer of the traffic signals to Flashing Operation. The fault is recorded by the Model 2018E and displayed on the appropriate LED indicators.

The Model 2018E monitor can operate in one of several basic configurations:

- 210 Monitor timings with 16 Channels using standard incandescent field display thresholds.
- 210 Monitor timings with 18 Channels using standard incandescent field display thresholds.
- 210 Monitor timings with 16 Channels using LED field display thresholds.
- 210 Monitor timings with 18 Channels using LED field display thresholds.
- 2010 Monitor timings with 16 Channels using standard incandescent field display thresholds.
- 2010 Monitor timings with 18 Channels using standard incandescent field display thresholds.
- 2010 Monitor timings with 16 Channels using LED field display thresholds.
- 2010 Monitor timings with 18 Channels using LED field display thresholds.

The differences between the 210 mode and the 2010 mode are:

AC Power - In the 210 mode, the AC Line voltage is considered valid at $>98V_{RMS}$ and invalid at $<92V_{RMS}$. In the 2010 mode, the AC Line voltage is considered valid at $>103V_{RMS}$ and invalid at $<98V_{RMS}$. (Now a new Factory Option)

Watchdog Timer Fault - In the 210 mode, a fault occurs if this input does not change states within 1500 milliseconds of the last state change. In the 2010 mode, a fault occurs if this input does not change states within 1000 milliseconds of the last state change.

Stop Timing - In the 210 mode, the Stop Timing output releases at the same time the Fault Relay returns to the no fault state. In the 2010 mode, the Stop Timing output releases 250 milliseconds before the Fault Relay returns to the no fault state.

Red Fail Timing - In the 210 mode, the Red Fail monitoring function will ignore faults of less than 700 milliseconds duration and trigger on faults of more than 1000 milliseconds duration. In the 2010 mode the Red Fail monitoring function will ignore faults of less than 1200 milliseconds duration and activate on faults of more than 1500 milliseconds duration.

Red Enable - In the 210 mode, a state change of the Red Enable input is recognized when it is in a state for at least 100 milliseconds. In the 2010 mode, a state change of the Red Enable input is recognized when it is in a state for at least 400 milliseconds.

The differences between the 16-channel and 18-channel mode are:

The 16-channel mode of operation can only be selected by inserting a 16-channel diode card into the monitor. In the 16-channel mode the monitor will only check the first 16 channels of the monitor for faults. Channels 17 and 18 are checked to ensure that no green or yellow input is active while the monitor is in the 16-channel mode. An active green or yellow on channel 17 or 18 will cause the monitor to transfer to the fault state with the **PC AJAR** and **CONFLICT** indications lit. While the monitor is operating normally in the 16-channel mode the red, yellow and green indications for channel 17 and 18 will display the function inhibited indication.

The 18-channel mode of operation can only be selected by inserting an 18-channel diode card into the monitor. In the 18-channel mode the monitor will perform the same fault tests for channels 17 and 18 as it would for the other 16 channels.

The differences between standard incandescent field display thresholds and the LED field display thresholds are:

With the incandescent thresholds, the monitor senses greens and yellows as ON when their voltage is above $25V_{RMS}$ and OFF when below $15V_{RMS}$. Reds are ON when their voltage is above $70V_{RMS}$ and OFF when below $50V_{RMS}$. Red Enable and Special Function Inputs are ON when their voltage is above $70V_{RMS}$ and OFF when below $50V_{RMS}$.

With the LED thresholds, the monitor—when checking for Conflicts, Multiple Indications, and Short Yellows—senses greens, yellows, and reds as ON when their voltage is above $25V_{RMS}$ and OFF when below $15V_{RMS}$. The Red Fail checks greens, yellows, and reds as ON when their voltage is above $70V_{RMS}$ and OFF when below $50V_{RMS}$. Red Enable and Special Function Inputs are ON when their voltage is above $70V_{RMS}$ and OFF when below $50V_{RMS}$.

The signal monitor portion of the monitor checks for the presence of voltage on conflicting field connection terminals in the Controller Assembly. For the purpose of conflict determination, a signal on any of the Green or Yellow inputs associated with a channel shall be considered as that channel being active.

The signal monitor portion of the monitor also checks for the absence of any required signal voltage on each channel at the field connection terminals in the Controller Assembly. For this purpose a signal on the Green, Yellow, or Red inputs associated with a channel shall be considered as that channel being active.

The voltage monitor portion of the monitor is capable of monitoring the Controller Watchdog output that indicates satisfactory operating conditions in the Controller Unit and the +24 volt direct current power supply.

The Model 2018E is fully programmable. An interchangeable Program Card is provided to allow the assignment of permissive or compatible channels. Programming is accomplished through the use of diodes soldered on the Program Card. The Program Card may be a sixteen- or eighteen-channel card. The Program Card is inserted into the monitor through a slot in the front panel. Two jumpers on the main board are available to force the monitor to accept only one of the two types of program cards.

Section 2 General Characteristics

The Model 2018E monitor was designed to meet and/or exceed the specifications in Chapter 3 Section 6 of the Caltrans Transportation Electrical Equipment Specifications (TEES) dated 08/16/02. The Model 2018E monitor includes several features designed to enhance the safety and operation of the monitor. These features extend the Model 2018E monitor features beyond the requirements of the Caltrans standards.

2.1 INPUTS

2.1.1 AC LINE (AC +)

The over-current protected side of 120-volt AC 60 Hz source. This input (Rear Edge Connector - Pin FF) is used to generate the voltages required to operate the monitoring logic.

The monitor has a printed circuit board mounted over-current protection device in the 120-volt AC input to the unit. This fuse is a 1/4 AMP SLO-BLOW and should only be replaced with a fuse of the same type and value.

Typical Connection: Cabinet AC Line power source.

2.1.2 AC NEUTRAL (AC -)

The un-fused and un-switched return side of 120-volt AC 60 Hz power source is taken from the neutral output of the AC power source. This input (Rear Edge Connector - Pin 21) is the referenced signal for all field terminal voltage sensing inputs. This input is not connected to Logic Ground or Earth Ground within the unit.

Typical Connection: Cabinet AC Neutral.

2.1.3 EARTH GROUND

The monitor has an input terminal (Rear Edge Connector - Pin U) providing an independent connection to the chassis of the unit. This input is not connected to DC Ground or AC Neutral within the unit.

Typical Connection: Cabinet Earth Ground.

2.1.4 FIELD TERMINALS (REDS, YELLOWS, AND GREENS)

The monitor has 54 field terminal inputs (18 Greens, 18 Yellows, and 18 Reds). 38 of these inputs are through the Rear Edge Connector (Channel 1-18 Greens, Channel 1-18 Yellows, and Channel 17 and 18 Reds). The other 16 inputs are through the front panel Red Interface Connector (Channel 1-16 Reds).

Each field terminal input is measured approximately 13,000 times per second to provide an accurate, true RMS (root mean square) AC voltage regardless of distortions in the waveform or changes in line frequency. Both positive and negative half wave rectified signals are sensed. The RMS voltage is calculated over the last two cycles of the line power (approximately 33 milliseconds) every cycle of the line power for every AC input. Voltages can be accessed in real-time via the serial port and are recorded in the Signal Sequence Log if a fault occurs.

Three inputs are provided for each channel to permit the monitoring of voltages at the Green / Walk, Yellow, and Red / Don't Walk signal field terminals.

In the Incandescent Mode (Incandescent Field Displays):

A Green or Yellow signal input is sensed as ON when it exceeds $25V_{RMS}$ and a signal input is sensed as OFF when it is less than $15V_{RMS}$. Signals between $15V_{RMS}$ and $25V_{RMS}$ may be in either state.

A Red signal input is sensed as ON when it exceeds $70V_{RMS}$ and a signal input is sensed as OFF when it is less than $50V_{RMS}$. Signals between $50V_{RMS}$ and $70V_{RMS}$ may be in either state.

In the LED mode (LED Field Displays):

For the purpose of testing for Conflicts, Multiple Indications, Flashing Don't Walk Monitoring, and ensuring that channels 17 and 18 are OFF when a 16-channel program card is used, a Green, Yellow, or Red signal input is sensed as ON when it exceeds $25V_{RMS}$ and a signal input is sensed as OFF when it is less than $15V_{RMS}$. Signals between $15V_{RMS}$ and $25V_{RMS}$ may be in either state.

For the purpose of testing for Red Fails, Co-Channel Childs, Short Yellows, and Short Clearance, a Green, Yellow, or Red signal input is sensed as ON when it exceeds $70V_{RMS}$ and a signal input is sensed as OFF when it is less than $50V_{RMS}$. Signals between $50V_{RMS}$ and $70V_{RMS}$ may be in either state.

When the circuit connected to the sensing input of the unit exhibits high impedance characteristics such as those caused by dimmers or burned out lamps, it may be necessary to place a low impedance device external to the unit between the unit input and AC Neutral.

Typical Connections: Field terminals for channel Reds, Yellows, and Greens as appropriate.

2.1.5 RED ENABLE

The presence of the proper voltage at this terminal (Red Interface Connector - Pin 20) enables the monitor to detect the absence of voltage on all field signal inputs of a channel.

The Red Enable input is sensed as ON when the input voltage exceeds $70V_{RMS}$ and is sensed as OFF when it is less than $50V_{RMS}$.

The Model 2018E will not recognize state changes of the Red Enable input while AC power is not valid. This ensures that short power interruptions do not cause unintended state changes of the Red Enable input.

When the Red Enable input is sensed as OFF the Multiple Indication and Short Yellow monitoring will be disabled unless the MI/SY ON (Multi Indication & Short Yellow Monitoring are Always ON) option jumper is installed.

Typical Connection: Control point that has 120VAC when the cabinet is in normal operation.

2.1.6 SPECIAL FUNCTION INPUTS

The monitor provides two Special Function inputs, Special Function 1 (Red Interface Connector – Pin 8) and Special Function 2 (Red Interface Connector – Pin 6). The presence of an active signal on these inputs disables the monitor's ability to detect the absence of voltage on all field signal inputs of a channel (Red Fail monitoring).

The Special Function inputs are sensed as ON when the input voltage exceeds $70V_{RMS}$ and are sensed as OFF when it is less than $50V_{RMS}$.

The Model 2018E will not recognize state changes of the Special Function inputs while AC power is not valid. This ensures that short power interruptions do not cause unintended state changes of the Special Function inputs.

There are two Option Switches (Special Function 1 Invert and Special Function 2 Invert) that allow the user to invert the ON and OFF states for each of the Special Function inputs. The *Special Func 2 Enable* user option in RaeComM must be selected in order for Special Function 2 to function.

Typical Connection: Unterminated or Preemption circuitry.

2.1.7 MC COIL INPUT

The monitor provides an input to monitor the state of the Mercury Contactor (MC) Coil (Rear Edge Connector – Pin EE). When this input is ON, the monitor disables the following functions: Red Fail monitoring, Flashing Don't Walk monitoring, Multiple Indication monitoring, and Short Yellow monitoring.

The MC Coil input is sensed as ON when the input voltage exceeds $70V_{RMS}$ and is sensed as OFF when it is less than $50V_{RMS}$.

The Model 2018E will not recognize state changes of the MC Coil input while AC power is not valid. This ensures that short power interruptions do not cause unintended state changes of the MC Coil input.

Typical Connection: MC Coil.

2.1.8 DC GROUND

A voltage reference point and current return for the External Reset input, Watchdog Timer input, +24 V Monitor input, and +24 VDC input circuits. This termination (Rear Edge Connector - Pin Y) is not connected to either the AC Neutral or Earth Ground within the unit.

Typical Connection: Power Supply DC Common.

2.1.9 +24 VDC INPUT

A +24-volt DC input (Rear Edge Connector - Pin 23 & Pin AA) is monitored to assure proper +24 VDC levels. The actual DC Voltage is measured and monitored at least 1000 times per second to ensure proper value. The 24 VDC Input can be accessed in real-time via the serial port. The actual voltage is also recorded in the Signal Sequence Log if a fault occurs.

Typical Connection: Power Supply +24VDC.

2.1.10 WATCHDOG TIMER INPUT

The Watchdog Timer input (Rear Edge Connector - Pin 22) is a logic level input. This signal must toggle between the low state (nominal 0VDC) and the high state (nominal 24VDC). When not pulled low, the input is internally biased to the high state (+24VDC). Actual Watchdog Timer voltage is measured and monitored at least 1000 times per second to determine the status of the input. The actual DC voltage level of the Watchdog Timer input can be accessed in real-time via the serial port. The actual voltage is also recorded in the Signal Sequence Log if a fault occurs.

Typical Connection: Controller Watchdog Output.

2.1.11 EXTERNAL RESET INPUT

The External Reset input (Rear Edge Connector - Pin Z) is a logic level input. A voltage of less than $4V_{DC}$ is recognized as a low and a voltage greater than $12V_{DC}$ is recognized as a high. This signal is low state for the true state. When not activated, the input is internally biased to the false (high) non-operate state (+24 VDC). Actual External Reset voltage is measured and monitored at least 1000 times per second to determine the status of the input. The actual DC voltage level of the External Reset input can be accessed in real-time via the serial port. The actual voltage is also recorded in the Signal Sequence Log if a fault occurs.

Typical Connection: Unterminated or tied to +24VDC. Should be used only for automated testing.

2.1.12 CABINET INTERLOCK

The monitor has two terminals internally connected to indicate the presence of the unit to the external circuitry. These terminals are on the Rear Edge Connector - Pin 24 and Pin 25.

Typical Connection: Interlock circuitry that will not allow the cabinet to operate normally with the monitor removed.

2.2 OUTPUTS

2.2.1 OUTPUT RELAY

The Output relay of the monitor has a set of isolated Form C contacts. These relay contacts are capable of switching all loads in the range from two milliamps at 18 volts DC to three amperes at $135V_{RMS}$.

The open circuit of the Output relay is the circuit that is open when the unit is in the No Fault state and all voltages are sufficient for proper operation of the Controller Assembly. The relay coil is energized in the No Fault state.

When operating in the 2010 mode, prior to the monitor transferring the Output relay contacts from the Fault state to the No Fault state, a transition state with a duration of 250 milliseconds occurs. During the transition state the Output relay contacts are the same as the Fault state and the monitor releases the Stop Timing output.

Typical Connection: Used to control the flash transfer relays.

2.2.2 STOP TIMING OUTPUT

The Stop Timing output of the monitor is an Open Collector output. When the output is active, the monitor will pull the Stop Timing output down to 0.8 volts or less.

When operating in the 2010 mode, prior to the monitor transferring the Output relay contacts from the Fault state to the No Fault state, a transition state with a duration of 250 milliseconds occurs. During the transition state, the Output relay contacts are the same as the Fault state and the monitor releases the Stop Timing output.

Typical Connection: Stop Timing input of the controller.

2.3 PROGRAMMING CARD

The monitor is fully programmable and requires programming action to provide configuration information. Programming is accomplished through the use of diodes and jumpers on an interchangeable Programming Card.

The Programming Card plugs into the monitor through a slot in the front panel. The monitor is constructed with card guides to ease the insertion of the Programming Card. The Programming Card includes card ejectors to ease removal of the Programming Card. The edge of the Programming Card is flush with the surface of the front panel when it is properly seated in the program card slot of the monitor. The **PC AJAR** LED will illuminate if the Programming Card is not properly seated while power is applied.

The monitor can use either a 16-channel Programming Card or an 18-channel Program Card. Refer to the table in section 2.6 for Programming Card connector pin assignments. The monitor can be configured to accept both types of Programming Cards or only one type. When configured to select only one type, the **PC AJAR** LED will illuminate if the inserted Program Card does not match the selected type.

See Section [3.5](#) for programming card connector pin assignments.

2.3.1 CHANNEL COMPATIBILITY (PERMISSIVES)

The monitor requires programming action to provide compatibility between channels. Programming is accomplished through the use of diodes on an interchangeable Programming Card. The diodes are logically labeled for easy identification by channel pairs. An installed functioning diode defines a pair of channels as conflicting. Removing a diode (cutting or unsoldering) defines a pair of channels as permissive or compatible.

2.3.2 YELLOW DISABLE

The Programming Card has sixteen or eighteen pairs of 1.09 mm (0.043 in) diameter holes for programming jumpers. One hole of each pair is connected to the Yellow Inhibit Common pin (pin #28). The sixteen or eighteen jumper-hole pairs are logically labeled for easy identification of the channel numbers. A soldered wire jumper in a

jumper-hole pair disables short or skipped yellow monitoring, removes the yellow from the multiple indication test for that channel, and removes the yellow from all conflict tests.

2.4 FEATURES

2.4.1 MONITOR POWER UP / POWER RECOVERY

When the AC+ input voltage exceeds $103V_{RMS}$ ($98V_{RMS}$ if the factory option for Low AC Power Thresholds is active) on power up or during power recovery, the monitor will begin a Power Up sequence.

On power up, the Output Relay contacts close.

The Stop Timing output becomes inactive.

The AC POWER indicator flashes at a 4 Hz rate.

A ten second max power up timer starts.

A four second delay is timed.

The monitor begins to count WATCHDOG TIMER transitions.

In the 210 mode of operation, if a transition occurs before the max power up timer reaches ten seconds, the Output relay contacts open and all monitoring functions become active.

In the 2010 mode of operation, if five transitions are counted before the max power up timer reaches ten seconds, the Output relay contacts open and all monitoring functions become active.

If the max power up timer reaches ten seconds, the Stop Timing output activates and a Watchdog Timer fault is generated and the **WDT ERROR** indicator turns on.

2.4.2 MONITOR POWER FAILURE

The monitor responds to a Power Failure by entering a non-latching flash state. The monitor responds to a Power Failure whether it is the result of over-current protection device operation, failure of the monitor power supply, absence of proper operating AC Line voltage, or absence of proper operating AC Line frequency as defined below.

The AC+ input is considered to be ON if the voltage level is greater than $103V_{RMS}$ AND the line frequency is between 57.5 Hz and 62.5 Hz. It is considered to be OFF if the voltage level drops to less than $98V_{RMS}$ or the line frequency becomes less than 56.0 Hz or greater than 64.0 Hz. The hysteresis from the OFF state to the ON state or vice versa is at least $3V_{RMS}$ and the line frequency hysteresis is at least 1.0 Hz. If the factory option for Low AC Power Thresholds is active, the AC+ input is considered to be ON if the voltage level is greater than $98V_{RMS}$ and it is considered to be OFF if the voltage level drops to less than $92V_{RMS}$.

The monitor responds to Power Failure as follows:

If the AC+ input is OFF for 400 milliseconds or less, the monitor continues to operate as though the AC+ input had remained ON. The Fault relay contacts do not transfer to the fault condition during this interval.

If the AC+ input is OFF for 450 milliseconds or more, the monitor transfers the Fault relay contacts to the fault condition. The time interval from the start of the AC+ input being OFF and the transfer of the Fault relay to the Fault state does not exceed 475 milliseconds. The relay maintains this state for the duration of the Power Failure and will enter the Power Recovery mode when power returns.

Power Failure lasting between 400 and 450 milliseconds may or may not cause the monitor to enter the power failure state.

2.4.3 RESET

Activation of the front panel manual reset switch or the Reset input causes the Form C Output relay contacts to transfer to the no fault condition. The monitor remains in the no fault condition only if no existing faults and all input voltages are at the proper operating levels.

Each activation of the front panel manual reset switch or the Reset input causes a one-time reset input to the monitor. A continuously activated front panel reset or Reset input will not prevent the monitor from monitoring any fault conditions and/or transferring the Output relay contacts to the fault condition. The front panel reset or Reset input must be removed and reapplied to activate a new reset input to the monitor. Activation of either reset will cause all of the front panel LEDs to turn on for 300 milliseconds.

The only intended purpose of the reset input is to facilitate automated testing of the monitor.

2.4.4 COM PORT

The monitor has a front panel mounted Mini USB communications port that can be used with Reno A&E's RaeComM software to view / modify configuration settings, view current status and voltages, view logs, and download firmware upgrades. The most current version of the RaeComM software can be found on the Reno A&E web site www.editraffic.com under support / monitor support / software. Also see Application Note AN-002 for an introduction to the RaeComM software. This application note can be found on the web site under support / monitor support / application notes.

The monitor was designed to use a standard USB to Mini USB extension cable for connecting to a laptop or computer. See Section 3.4 for connector pin assignments.

2.4.5 ETHERNET PORT

The monitor has an optional high speed, 10BASE-T / 100BASE-TX Ethernet network jack that can be used for communications with Reno A&E's RaeComM software to view / modify configuration settings, view current status and voltages, view logs, and download firmware upgrades.

To use this port an IP Address and port number must be set in the monitor. Contact your network administrator for addresses valid for your network. The factory default is an IP Address of 192.168.1.150 and port 10001 (this is the recommend value).

In order to prevent the accidental writing of information to an unintended monitor, the Ethernet port is read-only on power up. To make the Ethernet port read-write, press any pushbutton on the front of the monitor. This will unlock the monitor for a period of 15 minutes.

2.4.6 TEMPERATURE SENSOR

The monitor is capable of measuring the temperature inside of the cabinet. The temperature sensor is capable of measuring temperatures in the range of -40° F to +214° F (-40° C to +101° C). The internal cabinet temperature is included in the data logged into the Prior Faults Log when a fault occurs. If the actual temperature inside the cabinet is below -40° F (-40° C) at the time the fault occurs, the temperature is logged as -40° F (-40° C). If the actual temperature inside the cabinet is above +214° F (+101° C) at the time the fault occurs, the temperature is logged as +214° F (+101° C).

2.4.7 REAL TIME CLOCK

The monitor has a Real Time Clock (RTC) that is used as a reference for all date and time stamped events that are logged by the monitor. The Real Time Clock is initialized to local Pacific Standard Time when the unit is undergoing final test. In addition, the Daylight Saving Time user option is set to Off.

The Real Time Clock is preprogrammed to recognize Leap Years and Daylight Saving Time events through the year 2099. Currently, per U.S. Federal standards, Daylight Saving Time is observed in the United States from 2:00 A.M. on the second Sunday in March until 2:00 A.M. on the first Sunday in November.

The Real Time Clock setting can be modified through the use of the RaeComM software supplied with the monitor. This information is input into the Real Time Clock via the COMM PORT serial connector on the front of the monitor. Some controller manufacturers support our communications protocol and can synchronize the monitor to the controller's clock through a serial cable between the controller and the monitor.

If there is no connection made to the monitor via the COMM PORT connector, the date / time information stored in the internal Real Time Clock is used.

2.4.8 UP TIME ACCUMULATOR

The monitor has an Up Time Accumulator that keeps track of the total amount of time that the monitor has been powered up since it was manufactured. It is saved in the format of Years, Months, Days, Hours, Minutes, and Seconds. The monitor warranty coverage is valid for a total accumulated Monitor Up Time of two (2) years. Tracking and recording the total time that the unit was in service provides an accurate means of validating any potential warranty claims.

2.4.9 CONFIGURATION MONITORING (BEEPING MONITOR)

The monitor checks all configuration settings for changes once each second. If a change is found, an audible buzzer will start beeping (if not disabled), the **PC AJAR** indicator will flash at a 1 Hz rate, and the monitor will transfer to the fault state to indicate that a configuration setting has changed. If the change is undone, the beeping will stop and the monitor must be reset to resume normal operations. No configuration changes are implemented until the front panel reset pushbutton is pressed and held for five (5) seconds. At that time five quick confirmation beeps will be heard, the new settings will be implemented, the monitor will try to return to normal operation, and a Configuration Change log entry made.

The following configuration settings are monitored: Channel Permissives, Yellow Disable jumpers, Program Card type, printed circuit board DIP switches and jumpers, Factory Options, Electronic Options set through the RaeComM software, and Watchdog Disable.

2.4.10 FACTORY SETTINGS

The monitor is configured at the factory during final test. Data set at the factory includes: Model Number, Serial Number, Manufacture Date, Real Time Clock setting, Support for Flashing Greens, Fast Start-Up, Lower AC Power Thresholds, LA DOT configuration, NYS DOT configuration, and support for a Diagnostic LCD. The Up Time Accumulator is initialized to zero prior to final testing. Changes to any of the factory options are logged in the configuration log.

2.4.11 USER UNIT INFORMATION

The monitor has non-volatile memory that can be used to store the following user unit information: 40 character Location ID, 4 character Unit ID, and 5 character Agency ID. All of these IDs can consist of any alpha-numeric characters. Upper and lower case characters can be used.

2.5 FAULT MONITORING

2.5.1 CONFLICT MONITORING

Configuration: The diodes removed on the Program Card determine permissive (non-conflicting) channels. Removal of the diode labeled "2-6" would make Channels 2 and 6 permissive with each other. This is a two-way relationship. If channel 2 is programmed as permissive with channel 6 then channel 6 is automatically permissive with channel 2. The testing defaults for this feature are determined by the diodes removed on the program card. Typically no diodes are removed during automated testing.

Test Performed: While a channel has a Green or Yellow display active, the channel is tested to see if a non-permissive channel has a Green or Yellow display active at the same time. If concurrently active conflicting displays are detected a conflict timer is started. If the conflict goes away, the conflict timer is stopped (it is not cleared) and a non-conflict timer is started. If the conflict reappears the non-conflict timer is reset to zero and the conflict timer continues timing from its prior value. If the conflict timer reaches 333 milliseconds or more the monitor will latch a conflict fault. If the non-conflict timer reaches 666 milliseconds the conflict timer is reset to zero and the conflict is ignored. The normal voltage thresholds for this test are: Reds – ON when above $70V_{RMS}$ and OFF when below $50V_{RMS}$, Greens and Yellows – ON when above $25V_{RMS}$ and OFF when below $15V_{RMS}$.

Fault Action: The monitor transfers the Output relay contacts to the fault condition, activates the Stop Time output, and illuminates the **CONFLICT** indicator on the front panel. The Signal Sequence log and the Prior Faults log will record this fault.

Resetting the Fault: The monitor remains in this fault condition until the unit is reset by the activation of the front panel reset pushbutton or the activation of the reset input. Power loss or power interruption will not reset this fault. The Reset log will record the resetting of this fault.

Modifying Inputs:

MC Coil (Relay Output, Side 2): If Flashing Don't Walk Monitoring is enabled and channels have been programmed as active channels, flashing don't walk conflict testing will not be performed when this input is below $50V_{RMS}$ and will be performed when this input is above $70V_{RMS}$.

Feature Interactions:

Yellow Disable Jumpers: When Yellow Disable is jumpered for a channel that Yellow is removed from all conflict testing.

Flashing Don't Walk Monitoring: When Flashing Don't Walk Monitoring is enabled and channels have been programmed as active, a flashing red on a channel with this feature active will be included in the displays checked for conflicts. A conflict with a flashing red must exist for 1500 milliseconds to create a conflict fault.

Flashing Yellow Arrow Left Turns: When Flashing Yellow Arrow (FYA) Left Turns are enabled and FYA Ignore Yellow Conflict is enabled and a Channel has an FYA checked as a child channel that conflicts with this channel, a Yellow in that channel (if it is terminating a Flashing Yellow Arrow) and a Yellow in the child channel being active at the same time will be ignored as a conflict. Also, if a display is a Flashing Yellow Arrow it must flash. If it does not flash the monitor will remove the permissive with the programmed opposing channel thus causing a conflict with the Green or Yellow of the opposing channel if they are on.

LED Thresholds: When LED Thresholds is enabled the monitor senses Greens, Yellows, and Reds as ON when their voltage is above $25V_{RMS}$ and OFF when below $15V_{RMS}$ for the conflict test.

2.5.2 RED FAIL MONITORING

Configuration: All channels with a setting of "ON" for Red Fail switches will be monitored for the red fail fault. The testing defaults for this feature are all channels enabled for red fail testing.

Test Performed: When a channel has no displays active (Red, Yellow, or Green) a red fail timer is started. If a display turns on for the channel the red fail timer is stopped (it is not cleared) and a non-red fail timer is started. If

the no active display condition returns the non-red fail timer is reset to zero and the red fail timer continues timing from its prior value. If the red fail timer reaches 800 milliseconds or more the monitor will latch a red fail fault. If the non-red fail timer reaches 300 milliseconds the red fail timer is reset to zero and the red fail is ignored. The normal voltage thresholds for this test are: Reds – ON when above $70V_{RMS}$ and OFF when below $50V_{RMS}$, Greens and Yellows – ON when above $25V_{RMS}$ and OFF when below $15V_{RMS}$.

Fault Action: The monitor transfers the Output relay contacts to the fault condition, activates the Stop Time output, and illuminates the **RED FAIL** indicator on the front panel. The Signal Sequence log and the Prior Faults log will record this fault.

Resetting the Fault: The monitor remains in this fault condition until the unit is reset by the activation of the front panel reset pushbutton or the activation of the reset input. Power loss or power interruption will not reset this fault. The Reset log will record the resetting of this fault.

Modifying Inputs:

Red Enable: All red fail testing will be disabled when this input is below $50V_{RMS}$ and enabled when this input is above $70V_{RMS}$.

MC Coil (Relay Output, Side 2): All red fail testing will be disabled when this input is below $50V_{RMS}$ and enabled when this input is above $70V_{RMS}$.

Special Function 1: When operating normally, all red fail testing will be disabled when this input is below $50V_{RMS}$ and enabled when this input is above $70V_{RMS}$. When inverted, all red fail testing will be enabled when this input is below $50V_{RMS}$ and disabled when this input is above $70V_{RMS}$.

Special Function 2: This input has no effect unless it is enabled through the RacComM software. When operating normally, all red fail testing will be disabled when this input is below $50V_{RMS}$ and enabled when this input is above $70V_{RMS}$. When inverted, all red fail testing will be enabled when this input is below $50V_{RMS}$ and disabled when this input is above $70V_{RMS}$.

Feature Interactions:

Red Enable Must Be Active (Option Jumper 3): When Red Enable Must Be Active is jumpered the Red Enable input and at least one Red input must be active or a red fail fault will be generated.

Yellow Disable Jumpers: When Yellow Disable is jumpered for a channel that Yellow is removed from red fail testing for that channel. If the Yellow is a child of a Flashing Yellow Arrow channel, the Yellow will still be used in the parent channel's red fail test regardless of the Yellow Disable jumper setting of the child channel.

2010 Mode: When the 2010 mode of operation is enabled the timer thresholds are changed from 800 milliseconds to 1300 milliseconds for fault detection and the reset of the fault timer is still 300 milliseconds. NOTE: These times will be overridden by the Flashing Greens option if both features are active.

LED Thresholds: When LED Thresholds is enabled the Greens, Yellows, and Reds are sensed as ON when their voltage is above $70V_{RMS}$ and OFF when below $50V_{RMS}$ for the red fail test.

Flashing Greens (also known as Canadian Fast Flash): When Flashing Greens are enabled the timer thresholds are changed from 800 milliseconds to 1500 milliseconds for fault detection and from 300 milliseconds to 200 milliseconds for the reset of the fault timer. NOTE: These times will override the 2010 Mode times if both features are active.

Flashing Yellow Arrow Left Turns: When Flashing Yellow Arrow (FYA) Left Turns are enabled and a Channel has an FYA setting with a green border for one of its child channels (child channel is permissive with the parent channel), then the Green of the child channel will be included in the red fail test for that channel. If a Channel has an FYA setting with a yellow border for one of its child channels, then the Yellow of the child channel will be included in the red fail test for that channel.

2.5.3 DAUL INDICATION MONITORING

Configuration: All channels with a setting of "ON" for Dual Enable switches will be monitored for the dual indication fault. The testing defaults for this feature are all channels enabled for dual indication testing.

Test Preformed: The following dual indications are checked for: Yellow + Red, Green + Red, and Green + Yellow. When a channel has multiple displays active a dual indication timer is started. If one of the indications turns off the dual indication timer is stopped (it is not cleared) and a single indication timer is started. If both of the indications turn off the dual indication timer is stopped (it is not cleared) and a no indication timer is started. If the dual indication condition returns the single indication and no indication timers are stopped (not cleared) and the dual indication timer continues timing from its prior value. If the dual indication timer reaches 400 milliseconds or more the monitor will latch a dual indication fault. If the single indication timer reaches 1000 milliseconds the dual indication timer, the single indication timer, and the no indication timer are reset to zero and the dual

indication is ignored. If the no indication timer reaches 300 milliseconds the dual indication timer, the single indication timer, and the no indication timer are reset to zero and the dual indication is ignored. The normal voltage thresholds for this test are: Reds – ON when above 70V_{RMS} and OFF when below 50V_{RMS}, Greens and Yellows – ON when above 25V_{RMS} and OFF when below 15V_{RMS}.

Fault Action: The monitor transfers the Output relay contacts to the fault condition, activates the Stop Time output, and illuminates the **MULT IND** indicator on the front panel. The Signal Sequence log and the Prior Faults log will record this fault.

Resetting the Fault: The monitor remains in this fault condition until the unit is reset by the activation of the front panel reset pushbutton or the activation of the reset input. Power loss or power interruption will not reset this fault. The Reset log will record the resetting of this fault.

Modifying Inputs:

Red Enable: All dual indication testing will be disabled when this input is below 50V_{RMS} and enabled when this input is above 70V_{RMS}. NOTE: The disable function will be overridden when the Multi Indication & Short Yellow jumper is installed.

MC Coil (Relay Output, Side 2): All dual indication testing will be disabled when this input is below 50V_{RMS} and enabled when this input is above 70V_{RMS}. NOTE: The disable function will be overridden when the Multi Indication & Short Yellow jumper is installed.

Feature Interactions:

Yellow Disable Jumpers: When Yellow Disable is jumpered for a channel that Yellow is removed from dual indication testing for that channel. If the Yellow is a child of a Flashing Yellow Arrow channel, the Yellow will still be used in the parent channel's dual indication test regardless of the Yellow Disable jumper setting of the child channel.

Flashing Greens (also known as Canadian Fast Flash): When Flashing Greens are enabled the no indication timer thresholds for the Green + Red and Green + Yellow fault conditions are changed from 300 milliseconds to 100 milliseconds.

Flashing Yellow Arrow Left Turns: When Flashing Yellow Arrow (FYA) Left Turns are enabled and a Channel has an FYA setting with a green border for one of its child channels (child channel is permissive with the parent channel), then the Green of the child channel will be included in the dual indication test for that channel. If a Channel has an FYA setting with a yellow border for one of its child channels, then the Yellow of the child channel will be included in the dual indication test for that channel. This will effectively add the following dual indication tests: Red + FYA, Yellow + FYA, and Green + FYA. Also the timing thresholds are different for dual indications involving an FYA. The dual indication timer threshold is 1500 milliseconds, single indication timer threshold is 1000 milliseconds, and the no indication timer threshold is 300 milliseconds. The Dual Enable setting of the parent channel determines if the FYA display is tested. The Dual Enable setting for the permissive child only affects the non-FYA displays of that channel.

LED Thresholds: When LED Thresholds is enabled the monitor senses Greens, Yellows, and Reds as ON when their voltage is above 25V_{RMS} and OFF when below 15V_{RMS} for the dual indication test.

Multi Indication & Short Yellow Monitoring Jumper: When the Multi Indication & Short Yellow jumper is installed the monitor performs the Dual Indication testing regardless of the state of the Red Enable or MC Coil input.

2.5.4 SHORT YELLOW MONITORING

Configuration: Yellow Disable jumpers on the program card disable short Yellow monitoring for a channel. Typically, pedestrian channels will have Yellow Disable jumpers installed. The testing defaults for this feature are determined by the jumpers installed on the program card. Typically, no jumpers are installed during automated testing.

Test Performed: When a channel has a Green that turns off, a Yellow must follow it and it must stay on for at least 2.7 seconds. When each Green turns off a 2.7 second timer is started. A Yellow must start within 1.5 seconds of the Green turning off. If the Red turns on before the Yellow, a short Yellow fault will be generated to show that the Yellow was skipped. When a Yellow turns on for at least 100 milliseconds another 2.7 second timer is started and must reach zero before the yellow turns off or a short Yellow fault will be generated. The normal voltage thresholds for this test are: Reds – ON when above 70V_{RMS} and OFF when below 50V_{RMS}, Greens and Yellows – ON when above 25V_{RMS} and OFF when below 15V_{RMS}.

Fault Action: The monitor transfers the Output relay contacts to the fault condition, activates the Stop Time output, and illuminates the **YELLOW** indicator on the front panel. The Signal Sequence log and the Prior Faults log will record this fault.

Resetting the Fault: The monitor remains in this fault condition until the unit is reset by the activation of the front panel reset pushbutton or the activation of the reset input. Power loss or power interruption will not reset this fault. The Reset log will record the resetting of this fault.

Modifying Inputs:

Red Enable: All short Yellow testing will be disabled when this input is below 50V_{RMS} and enabled when this input is above 70V_{RMS}. NOTE: The disable function will be overridden when the Multi Indication & Short Yellow jumper is installed.

MC Coil (Relay Output, Side 2): All short Yellow testing will be disabled when this input is below 50V_{RMS} and enabled when this input is above 70V_{RMS}.

Feature Interactions:

Yellow Disable Jumpers: When Yellow Disable is jumpered for a channel that Yellow is removed from short Yellow testing. If the Yellow is a child of a Flashing Yellow Arrow channel, the Yellow Disable jumper should be installed for the child channel.

LED Thresholds: When LED Thresholds is enabled the monitor senses Greens, Yellows, and Reds as ON when their voltage is above 70V_{RMS} and OFF when below 50V_{RMS} for the short Yellow test.

Flashing Yellow Arrow Left Turns: When Flashing Yellow Arrow (FYA) Left Turns are enabled and a Channel has an FYA setting with a green or yellow border for one of its child channels (child channel is permissive with the parent channel), then the Yellow of the parent channel will be used for terminating the Yellow or Green of the child channel and will be checked for short Yellow and skipped Yellow.

Multi Indication & Short Yellow Monitoring Jumper: When the Multi Indication & Short Yellow jumper is installed the monitor performs the short Yellow testing regardless of the state of the Red Enable input.

2.5.5 SHORT CLEARANCE MONITORING

Configuration: Short clearance monitoring is performed on all channels.

Test Performed: When a channel has a Green that turns off, a conflicting channel cannot display a Green or Yellow for at least 2.7 seconds. When each Green turns off a 2.7 second timer is started. If a conflicting Green or Yellow turns on for at least 100 milliseconds the 2.7 second timer must have reached zero or a fault will be generated. The normal voltage thresholds for this test are: Greens and Yellows – ON when above 25V_{RMS} and OFF when below 15V_{RMS}.

Fault Action: The monitor transfers the Output relay contacts to the fault condition, activates the Stop Time output, and illuminates the **YELLOW** indicator on the front panel. The Signal Sequence log and the Prior Faults log will record this fault.

Resetting the Fault: The monitor remains in this fault condition until the unit is reset by the activation of the front panel reset pushbutton or the activation of the reset input. Power loss or power interruption will not reset this fault. The Reset log will record the resetting of this fault.

Modifying Inputs:

Red Enable: All short clearance testing will be disabled when this input is below 50V_{RMS} and enabled when this input is above 70V_{RMS}. NOTE: The disable function will be overridden when the Multi Indication & Short Yellow jumper is installed.

MC Coil (Relay Output, Side 2): All short clearance testing will be disabled when this input is below 50V_{RMS} and enabled when this input is above 70V_{RMS}.

Feature Interactions:

Yellow Disable Jumpers: When Yellow Disable is jumpered for a channel that Yellow is removed from short clearance testing when looking for conflicting displays.

LED Thresholds: When LED Thresholds is enabled the monitor senses Greens and Yellows as ON when their voltage is above 70V_{RMS} and OFF when below 50V_{RMS} for the short Yellow test.

Flashing Yellow Arrow Left Turns: When Flashing Yellow Arrow (FYA) Left Turns are enabled and a Channel has an FYA setting with a green or yellow border for one of its child channels (child channel is permissive with the parent channel), then that child, whether green or yellow, will be checked for short clearance.

Multi Indication & Short Yellow Monitoring Jumper: When the Multi Indication & Short Yellow jumper is installed the monitor performs the short clearance testing regardless of the state of the Red Enable input.

2.5.6 +24 VOLTS DC MONITORING

Configuration: +24VDC monitoring is always performed.

Test Performed: A voltage greater than +22V_{DC} applied to the +24 Volt input is recognized as adequate for proper operation. A voltage of less than +18V_{DC} is recognized as inadequate for proper operation. When the +24 Volt input is detected as inadequate for more than 350 milliseconds, the monitor generates a fault. A +24V failure during the power up or power recovery sequence shall not cause a fault.

Fault Action: The monitor transfers the Output relay contacts to the fault condition, activates the Stop Time output, and illuminates the **VDC FAILED** indicator on the front panel. The Signal Sequence log and the Prior Faults log will record this fault.

Resetting the Fault: The monitor remains in this fault condition until the unit is reset by the activation of the front panel reset pushbutton or the activation of the reset input. Power loss or power interruption will not reset this fault. The Reset log will record the resetting of this fault.

Modifying Inputs:

None

Feature Interactions:

+24VDC Enhanced Monitoring: When enabled, high voltage monitoring and ripple monitoring will be performed on the +24VDC input as well as the low voltage monitoring.

2.5.7 WATCHDOG MONITORING

Configuration: The setting of Watchdog switch determines if this feature is active. The testing default for this feature should be enabled.

NOTE: The Model 2018E monitor can be factory configured without the Watchdog switch. If the switch is not present, the monitor will operate with the Watchdog monitoring function permanently enabled.

Test Performed: The Watchdog Timer input (Rear Edge Connector - Pin 22) is monitored. A voltage of less than 4V_{DC} is recognized as a low and a voltage greater than 12V_{DC} is recognized as a high. The input must change states at least once every 1500 milliseconds or the monitor generates a fault. Testing is disabled if the line voltage drops below 98V_{RMS} and enabled when the line voltage goes above 103V_{RMS}.

Fault Action: The monitor transfers the Output relay contacts to the fault condition, activates the Stop Time output, and flashes the **WDT ERROR** indicator on the front panel. The Signal Sequence log and the Prior Faults log will record this fault.

Resetting the Fault: The monitor remains in this fault condition until the unit is reset by the activation of the front panel reset pushbutton or the activation of the reset input. Power loss or power interruption will not reset this fault. The Reset log will record the resetting of this fault.

Modifying Inputs:

None

Feature Interactions:

2010 Mode: When the 2010 mode of operation is enabled the timer threshold is changed from 1500 milliseconds to 1000 milliseconds for fault detection.

Force Watchdog to 1500 Milliseconds: When the 2010 mode of operation is enabled the timer threshold is forced to stay at 1500 milliseconds for fault detection.

2.5.8 PROGRAMMING CARD ABSENT MONITORING

Configuration: Program Card absent monitoring is always performed.

Test Performed: If the programming card is not present or not seated properly in the connector the monitor generates a fault.

Fault Action: The monitor transfers the Output relay contacts to the fault condition, activates the Stop Time output, and illuminates the **PC AJAR** indicator on the front panel. The Signal Sequence log and the Prior Faults log will record this fault.

Resetting the Fault: Proper insertion of a Program Card is required before the fault can be reset. The monitor remains in this fault condition until the unit is reset by the activation of the front panel reset pushbutton, or activation of the reset input. The Reset log will record the resetting of this fault.

Modifying Inputs:

None

Feature Interactions:

Do Not Allow 16 Channel Program Card: When this feature is jumpered, the monitor will not reset from fault while a 16 channel program card is installed.

Do Not Allow 18 Channel Program Card: When this feature is jumpered, the monitor will not reset from fault while a 18 channel program card is installed.

2.6 OPERATION MODIFIERS

2.6.1 OPTION SWITCHES

2.6.1.1 OPTION SWITCH 1 – FLASHING DON'T WALK MONITORING – DW MON

Configuration: The Flashing Don't Walk Monitoring configuration consists of two settings.

Flashing Don't Walk Monitoring Enable: The setting of the Flashing Don't Walk Monitoring Enable (Option Switch 1 – DW MON) DIP switch determines if this feature is active. Turning this feature ON will activate the other the flashing Don't Walk configuration settings.

Flashing Don't Walk Monitoring Channels: All channels with a setting of enabled for Flashing Don't Walk Monitoring will include a flashing red on that channel in the displays checked for conflicts. The per channel settings can only be modified through the RaeComM software.

The testing defaults for this feature should be all channels disabled for Flashing Don't Walk Monitoring testing and Flashing Don't Walk Monitoring Enabled set to OFF.

Operations Modified:

Conflict Monitoring: Normal conflict testing checks active Green and Yellow displays for being permissive. With this feature active, any channel with a setting of enabled will have a flashing Red included in the channels checked as permissive. A flashing input is defined as an input that stays ON for at least 200 milliseconds and no longer than 600 milliseconds and is OFF for at least 200 milliseconds and no longer than 600 milliseconds. A Flashing Don't Walk conflict must exist for 1500 milliseconds to be detected as a fault. This time allows the monitor sufficient time to detect transitions from the flashing state to the solid on state and not falsely trip.

Typical Use: This feature is used to provide additional fault checking for Flashing Don't Walk displays on pedestrian channels. Without this feature a flashing Red input is never checked for conflicts.

2.6.1.2 OPTION SWITCH 2 – FLASHING YELLOW ARROW MONITORING – FYA EN

Configuration: The Flashing Yellow Arrow (FYA) left turn configuration consists of five different settings.

FYA Enable: The setting of the Flashing Yellow Arrow Enable (Option Switch 2 – FYA EN) DIP switch determines if this feature is active. Turning this feature ON will activate the other the FYA features - FYA Childs, FYA Ignore Yellow Conflict, FYA 1-4 Uses Yellow, and FYA 5-18 Uses Yellow.

FYA Ignore Yellow Conflict: Turning this feature ON will force the monitor to ignore Yellow-Yellow conflicts between the parent FYA channel and the conflicting child channel when terminating a flashing Yellow arrow display. If the Green arrow is being terminated, the Yellow arrow will still conflict with the conflict child channel Yellow. This setting can only be modified through the RaeComM software.

FYA 1-4 Uses Yellow: If any of channels 1 through 4 will be a parent (the protected display) channel for a Flashing Yellow Arrow head, this is feature is used to select which driver from the child (the permissive display) channel will be used to make up the four sections of the Flashing Yellow Arrow head. ON (checked) indicates that the Yellow of the child channel will be used. OFF (unchecked) indicates that the Green of the child channel will be used. This setting can only be modified through the RaeComM software.

FYA 5-18 Uses Yellow: If any of channels 5 through 18 will be a parent (the protected display) channel for a Flashing Yellow Arrow head, this is feature is used to select which driver from the child (the permissive display) channel will be used to make up the four sections of the Flashing Yellow Arrow head. ON (checked) indicates that the Yellow of the child channel will be used. OFF (unchecked) indicates that the Green of the child channel will be used. This setting can only be modified through the RaeComM software.

FYA Childs: When a child channel is selected, the monitor will determine if the child is permissive or conflicting with the parent channel based on the Program Card. If permissive, the child will have a green border or a yellow border based on the setting of FYA 1-4 Uses Yellow and FYA 5-18 Uses Yellow. If conflicting, the child will have a red border. These settings can only be modified through the RaeComM software.

The testing defaults for these features should be: FYA Enable set to OFF, FYA Ignore Yellow Conflict set to OFF, FYA 1-4 Uses Yellow set to OFF, FYA 5-18 Uses Yellow set to OFF, and all FYA Childs disabled.

Operations Modified:

Conflict Monitoring: Normal conflict testing checks active Green and Yellow displays for being permissive. With FYA Enable set to yes and FYA Ignore Yellow Conflict set to yes, the monitor will ignore a Yellow-Yellow conflict between a channel yellow and its conflicting child yellow (channel marked with a red border) if the Yellow is terminating a flashing Yellow arrow display. With FYA Enable set to yes, any channel check box with a green or yellow border for a child channel will have the appropriate display (Green or Yellow) of the child channel monitored for a flashing condition. A flashing input is defined as an input that stays ON for at least 200 milliseconds and no longer than 600 milliseconds and is OFF for at least 200 milliseconds and no longer than 600 milliseconds. If the input does not flash (stays on solid) the monitor will create a conflict with the conflicting child (channel marked with a red border) even though the two channels are usually jumpered as permissive.

Red Fail Monitoring: Normal red fail testing ensures that at least one display is active for a channel. With this feature active, any channel with a checked box with a green or yellow border for a child channel will have the appropriate display (Green or Yellow) of the child channel included when checking for a red fail of the parent channel.

Dual Indication Monitoring: Normal dual indication testing ensures that only one display for a channel is active at a time. With FYA Enable set to yes, any channel with a child with a green or yellow border will have the appropriate display (Green or Yellow) of the child channel included when checking for a dual indication.

Short Yellow Monitoring: When Flashing Yellow Arrow (FYA) Left Turns are enabled and a channel has an FYA setting with a green or yellow border for one of its child channels, then the Yellow of the parent channel will be used for terminating the Yellow or Green of the child channel and will be checked for short yellow and skipped yellow.

Short Clearance Monitoring: When Flashing Yellow Arrow (FYA) Left Turns are enabled and a channel has an FYA setting with a green or yellow border for one of its child channels, then that child will be checked for short clearance.

Typical Use: See Application Note AN-005 for detailed examples of this feature. The intended field wiring connections for this feature are the Red, Yellow, and Green arrows connected to the parent channel and the flashing Yellow arrow connected to the Green or Yellow of the permissive child channel. If channel 1 is the protected left turn and will have an FYA display driven by the channel 9 green and the yellow of channel 1 will be ON at the same time as the yellow of channel 2 to terminate a flashing yellow arrow, the configuration would be: FYA Enable should be ON, Channel 1 will have child of channel 2 and channel 9, FYA 1-4 Uses Yellow should be OFF, FYA 5-18 Uses Yellow should be OFF, and FYA Ignore Yellow Conflict should be ON.

Care should be taken to insure that the possible phase sequencing does not allow the flashing Yellow arrow to terminate while its opposing through is still green. Be sure to check pre-emption sequencing as well.

2.6.1.3 OPTION SWITCH 3 - +24VDC ENHANCED MONITORING – 24V ENH

Configuration: The setting of the +24VDC Enhanced Monitoring Enable (Option Switch 3 – 24V ENH) DIP switch determines if this feature is active. This feature allows for over voltage monitoring and ripple voltage monitoring. The testing default for this feature should be disabled.

Operations Modified:

+24VDC Monitoring: When +24VDC Enhanced Monitoring is enabled, the voltage on the +24VDC input is also monitored for over voltage monitoring with greater than $30V_{DC}$ being a fault, and ripple voltage monitoring with greater than $1V_{RMS}$ being a fault. The **VDC FAILED** indicator will flash at a 5 Hz rate when there is an over voltage fault and the indicator will flash at a 1 Hz rate when there is a ripple fault.

Typical Use: This feature can be useful for early detection of power supply failures before they may damage equipment

2.6.1.4 OPTION SWITCH 4 – SPECIAL FUNCTION 1 INVERT – SF1 INV

Configuration: The setting of the Special Function 1 Invert Enable (Option Switch 4 – SF1 INV) DIP switch determines if this feature is active. When the switch is OFF, the Special Function 1 input is sensed as active when the voltage is greater than $70V_{RMS}$ for 550 milliseconds or off when the voltage is less than $50V_{RMS}$ for 550

milliseconds. When the switch is set to ON, the Special Function 1 input is sensed as active when the voltage is less than $50V_{RMS}$ for 550 milliseconds and off when the voltage is greater than $70V_{RMS}$ for 550 milliseconds. The testing default for this feature should be disabled.

Operations Modified:

Red Fail Monitoring: When Special Function 1 Invert is enabled and the voltage on the Special Function 1 input is less than $50V_{RMS}$ for 550 milliseconds, red fail monitoring shall be disabled.

Typical Use: This feature can be useful for railroad preemption interfacing. Railroad circuits are commonly energized when not active and de-energized when active.

2.6.1.5 OPTION SWITCH 5 – SPECIAL FUNCTION 2 INVERT – SF2 INV

Configuration: The setting of the Special Function 2 Invert Enable (Option Switch 5 – SF2 INV) DIP switch determines if this feature is active. When the switch is OFF, the Special Function 2 input is sensed as active when the voltage is greater than $70V_{RMS}$ for 550 milliseconds or off when the voltage is less than $50V_{RMS}$ for 550 milliseconds. When the switch is set to ON, the Special Function 2 input is sensed as active when the voltage is less than $50V_{RMS}$ for 550 milliseconds and off when the voltage is greater than $70V_{RMS}$ for 550 milliseconds. The testing default for this feature should be disabled. The *Special Func 2 Enable* user option in RaeComM must be selected in order for Special Function 2 to function.

Operations Modified:

Red Fail Monitoring: When Special Function 2 is enabled, Special Function 2 Invert is enabled, and the voltage on the Special Function 2 input is less than $50V_{RMS}$ for 550 milliseconds, red fail monitoring shall be disabled.

Typical Use: This feature can be useful for railroad preemption interfacing. Railroad circuits are commonly energized when not active and de-energized when active.

2.6.1.6 OPTION SWITCH 6 – GREEN / YELLOW MONITORING – GY MON

Configuration: The setting of the Special Function 2 Invert Enable (Option Switch 5 – SF2 INV) DIP switch determines if this feature is active. When the switch is OFF, the Special Function 2 input is sensed as active when the voltage is greater than $70V_{RMS}$ for 550 milliseconds or off when the voltage is less than $50V_{RMS}$ for 550 milliseconds. When the switch is set to ON, the Special Function 2 input is sensed as active when the voltage is less than $50V_{RMS}$ for 550 milliseconds and off when the voltage is greater than $70V_{RMS}$ for 550 milliseconds. The testing default for this feature should be disabled. The *Special Func 2 Enable* user option in RaeComM must be selected in order for Special Function 2 to function.

Operations Modified:

Red Fail Monitoring: When Special Function 2 is enabled, Special Function 2 Invert is enabled, and the voltage on the Special Function 2 input is less than $50V_{RMS}$ for 550 milliseconds, red fail monitoring shall be disabled.

Typical Use: This feature can be useful for railroad preemption interfacing. Railroad circuits are commonly energized when not active and de-energized when active.

2.6.1.7 OPTION SWITCH 7 – 2010 MODE - 2010

Configuration: The setting of the 2010 Mode (Option Switch 7 - 2010) DIP switch determines if this feature is active. The 210 mode of operation is selected when the switch is OFF. The 2010 mode of operation is selected when the switch is ON.

Operations Modified:

Watchdog Monitoring: In the 210 mode a fault occurs if this input does not change states within 1500 milliseconds of the last state change. In the 2010 mode a fault occurs if this input does not change states within 1000 milliseconds of the last state change.

Red Fail Monitoring: In the 210 mode the Red Fail monitoring function shall ignore faults of less than 700 milliseconds duration and activates on faults of more than 1000 milliseconds duration. In the 2010 mode the Red Fail monitoring function will ignore faults of less than 1200 milliseconds duration and activate on faults of more than 1500 milliseconds duration.

Stop Timing: In the 210 mode the Stop Timing output is released at the same time as the Fault Relay is returned to the no fault state. In the 2010 mode the Stop Timing output is released 250 milliseconds before the Fault Relay is returned to the no fault state.

Red Enable: In the 210 mode a state change of the Red Enable input is recognized when it stays in a state for at least 100 milliseconds. In the 2010 mode a state change of the Red Enable input is recognized when it is in a state for at least 400 milliseconds.

Typical Use: This feature is used to provide additional fault checking for Flashing Don't Walk displays on pedestrian channels. Without this feature a flashing Red input is never checked for conflicts.

2.6.1.8 OPTION SWITCH 8 – LED THRESHOLDS – LED THR

Configuration: The setting of the LED Thresholds Enable (Option Switch 8 – LED THR) DIP switch determines if this feature is active. The standard incandescent field display thresholds are selected when the switch is OFF. The enhanced LED field display thresholds are selected when the switch is set to ON.

Operations Modified:

Conflict Monitoring: Normal conflict testing senses Greens and Yellows as ON when their voltage is above $25V_{RMS}$ and OFF when below $15V_{RMS}$. Reds are ON when their voltage is above $70V_{RMS}$ and OFF when below $50V_{RMS}$. With LED thresholds, the monitor senses Greens, Yellows, and Reds as ON when their voltage is above $25V_{RMS}$ and OFF when below $15V_{RMS}$.

Red Fail Monitoring: Normal red fail testing senses Greens, Yellows, and Walks as ON when their voltage is above $25V_{RMS}$ and OFF when below $15V_{RMS}$. Reds are ON when their voltage is above $70V_{RMS}$ and OFF when below $50V_{RMS}$. With LED thresholds, the monitor senses Greens, Yellows, Reds, and Walks are sensed as ON when their voltage is above $70V_{RMS}$ and OFF when below $50V_{RMS}$.

Dual Indication Monitoring: Normal dual indication testing senses Greens, Yellows, and Walks as ON when their voltage is above $25V_{RMS}$ and OFF when below $15V_{RMS}$. Reds are ON when their voltage is above $70V_{RMS}$ and OFF when below $50V_{RMS}$. With LED thresholds, the monitor senses Greens, Yellows, Reds, and Walks as ON when their voltage is above $25V_{RMS}$ and OFF when below $15V_{RMS}$.

Short Yellow Monitoring: Normal short Yellow testing senses Greens, Yellows, and Walks as ON when their voltage is above $25V_{RMS}$ and OFF when below $15V_{RMS}$. Reds are ON when their voltage is above $70V_{RMS}$ and OFF when below $50V_{RMS}$. With LED thresholds, the monitor senses Greens, Yellows, Reds, and Walks are sensed as ON when their voltage is above $70V_{RMS}$ and OFF when below $50V_{RMS}$.

Short Clearance Monitoring: Normal short Yellow testing senses Greens, Yellows, and Walks as ON when their voltage is above $25V_{RMS}$ and OFF when below $15V_{RMS}$. Reds are ON when their voltage is above $70V_{RMS}$ and OFF when below $50V_{RMS}$. With LED thresholds, the monitor senses Greens, Yellows, Reds, and Walks are sensed as ON when their voltage is above $70V_{RMS}$ and OFF when below $50V_{RMS}$.

Typical Use: Once any LED field displays are installed, using LED Thresholds will provide better fault checking by using voltage thresholds that are specifically suited to each type of test being performed.

2.6.2 OPTION JUMPERS

2.6.2.1 OPTION JUMPER 1 – DO NOT ALLOW 16 CHANNEL PROGRAM CARD – NO CH16

Configuration: The installation of the Do Not Allow 16 Channel Program Card (Option Jumper 1 – NO 16CH) jumper determines if this feature is active.

Operations Modified:

Program Card Absent Monitoring: When Do Not Allow 16 Channel Program Card is enabled and a 16 channel Program Card is installed, a **PC AJAR** fault will be generated with all three field indications for channels 1 through 16 flashing.

Typical Use: This feature is used to force the monitor to not accept 16 channel Program Cards when channels 17 and/or 18 are being used. Without it, the monitor will accept either type of Program Card.

2.6.2.2 OPTION JUMPER 2 – DO NOT ALLOW 18 CHANNEL PROGRAM CARD – NO CH18

Configuration: The installation of the Do Not Allow 18 Channel Program Card (Option Jumper 2 – NO 18CH) jumper determines if this feature is active.

Operations Modified:

Program Card Absent Monitoring: When Do Not Allow 18 Channel Program Card is enabled and an 18 channel Program Card is installed, a **PC AJAR** fault will be generated with all three field indications for channels 1 through 18 flashing.

Front Panel Field Display: When Do Not Allow 18 Channel Program Card is enabled, the channel 17 and 18 Red, Yellow, and Green field indications will not show the function disabled blip when a 16 channel Program Card is installed.

Typical Use: This feature is used to force the monitor to not accept 18 channel Program Cards when channels 17 and 18 are not being used. Without it, the monitor will accept either type of Program Card.

2.6.2.3 OPTION JUMPER 3 – RED ENABLE MUST BE ACTIVE – RED EN

Configuration: The installation of the Red Enable Must be Active (Option Jumper 3 – RED EN) jumper determines if this feature is active. Special Function 1 and 2 inputs can be used to disable Red Fail monitoring, if that function is needed while this feature is active.

Operations Modified:

Red Fail Monitoring: When Red Enable Must be Active is enabled, the Red Enable input and at least one Red input must be active or a red fail fault will be generated.

Typical Use: This feature is used to force the use of the Red Interface cable. Without it, the Red Interface cable could be left unplugged and the monitor would allow normal operations, just without red fail monitoring, dual indication monitoring, short Yellow monitoring, and short clearance monitoring.

2.6.2.4 OPTION JUMPER 4 – MULTI INDICATION & SHORT YELLOW MONITORING – MI/SY ON

Configuration: The installation of the Multiple Indication and Short Yellow Monitoring (Option Jumper 4 – MI/SY ON) jumper determines if this feature is active.

Operations Modified:

Dual Indication Monitoring: When Multiple Indication and Short Yellow Monitoring is enabled, the Dual Indication tests are always performed regardless of the state of the Red Enable input.

Short Yellow Monitoring: When Multiple Indication and Short Yellow Monitoring is enabled, the Short Yellow tests are always performed regardless of the state of the Red Enable input.

Short Clearance Monitoring: When Multiple Indication and Short Yellow Monitoring is enabled, the Short Clearance tests are always performed regardless of the state of the Red Enable input.

Typical Use: This feature is useful when the user wants to ensure that the Multiple (Dual) Indication, Short Yellow, and Short Clearance monitoring are always active. These functions are normally disabled when the Red Enable input is not active.

2.6.3 FACTORY OPTIONS

2.6.3.1 GREEN FLASH (CANADIAN FAST FLASH)

Configuration: This is a factory option and cannot be changed by the user. If this function is required but it is not active, contact Reno A&E Technical Support for assistance. This feature is set to OFF for units sold in the United States and set to ON for units shipped to Canada.

Operations Modified:

Please refer to Reno A&E Application Note AN-004 in the Support section of the Reno A&E web site (renoae.com) under Monitor Support / Application Notes for a detailed description of how these tests are modified.

Red Fail Monitoring: Red Fail Fault time is changed from 800 milliseconds to 1.5 seconds. Red Fail Reset time is changed from 300 milliseconds to 200 milliseconds.

Dual Indication Monitoring: Green-Yellow Dual Indication Reset time is changed from 300 milliseconds to 100 milliseconds. Green-Red Dual Indication Reset time is changed from 300 milliseconds to 100 milliseconds.

Typical Use: This feature is intended to support the use of flashing Green indications as used in Canada.

2.6.3.2 FAST START UP

Configuration: This is a factory option and cannot be changed by the user. If this function is required but it is not active, contact Reno A&E Technical Support for assistance. This feature is set to OFF for all units unless specifically requested to be turned on when ordered. NOTE: The same effect can be achieved by holding in the front panel Reset switch while the monitor is powered up.

Operations Modified:

Monitor Power Up / Power Recovery: When Fast Start Up is enabled, the four second delay is removed and replaced with actual boot time (approximately 800 milliseconds). Also, if operating in the 2010 mode of operation, the requirement for five watchdog transitions before exiting start up flash is removed. Five watchdog transitions must still be detected before the ten second max power up timer expires.

Typical Use: Some agencies prefer that the monitor power up as fast as possible and allow normal operation of the intersection as soon as possible to minimize flash time, especially if the monitor is plugged in while the intersection is already running. Without this feature, the monitor will always take at least four seconds to power up and allow normal operation of the intersection. With this feature, the start up flash time will be less than one second.

2.6.3.3 LOW AC POWER THRESHOLDS

Configuration: This is a factory option and cannot be changed by the user. If this function is required but it is not active, contact Reno A&E Technical Support for assistance. This feature is set to OFF for all units unless specifically requested to be turned on when ordered.

Operations Modified:

Monitor Power Up / Power Recovery: When Low AC Power Thresholds is enabled, the valid AC voltage threshold is changed from 103V_{RMS} to 98V_{RMS}.

Monitor Power Failure: When Low AC Power Thresholds is enabled, the invalid AC voltage threshold is changed from 98V_{RMS} to 92V_{RMS}.

Typical Use: Some agencies prefer the lower AC power thresholds especially in areas with chronic low voltage issues.

2.6.3.4 DIAGNOSTIC LCD

Configuration: This is a factory option and cannot be changed by the user. If this function is required but it is not active, contact Reno A&E Technical Support for assistance. This feature is set to OFF for all units.

Operations Modified:

Diagnostic LCD: The monitor is capable of driving a special 4 line by 40 character diagnostic display. This display can display any of over 40 diagnostic screens. The active screen is selected using Option Switches 3 through 8. When this feature is enabled, any changes to these six Option Switches will not cause configuration changes, only change the active diagnostic screen. The state of the Option Switches prior to the activation of this feature will be used until this feature is turned off.

Typical Use: Troubleshooting of monitor issues by factory personnel.

2.6.4 SOFTWARE OPTIONS

2.6.4.1 LOG FIELD CHANGES

Configuration: This is a feature that can only be modified through the use of the RaeComM software and a computer or laptop. In the RaeComM software click on the wrench icon or on the menu choose Config / Monitor Configuration. This feature is on the Electronic Options tab and in the Software Option box in the lower right. This feature is set to OFF at the factory.

Operations Modified:

Signal Sequence Log: When Log Field Changes is enabled, the Signal Sequence log will change from recording the state and voltage on every input every 33 milliseconds to checking every 33 milliseconds to see if the state of any input changed. The Watchdog input will not be included in the inputs checked for state changes. If there were no state changes, length of the current log entry is increased by 33 milliseconds and no new log entry is made. If there were state changes, a new log entry is made and the voltages are recorded at this point.

Typical Use: Since the Signal Sequence log has 60 entries, at 33 milliseconds per entry, the log can only record the events for two seconds prior to the fault. With this feature, the monitor can record the 60 state changes prior to the fault. How far back in time this will record will depend on how often inputs are changing states. A typical intersection with pedestrian movements will record about 40 seconds.

2.6.4.2 FYA FOR CHANNELS 1-4 USE YELLOW DRIVERS (FYA 1-4 USES YEL)

Configuration: This feature is only effective if Flashing Yellow Arrow Enable (Option Switch 2 – FYA EN) is active. If any of channels 1 through 4 will be a parent (the protected display) channel for a Flashing Yellow Arrow head, this feature is used to select which driver from the permissive child channel will be used to make up the four sections of the Flashing Yellow Arrow head. ON (checked) indicates that the Yellow of the child channel will be used. OFF (unchecked) indicates that the Green of the child channel will be used. This feature can only be modified through the use of the RaeComM software and a computer or laptop. In the RaeComM software click on the wrench icon or on the menu choose Config / Monitor Configuration. This feature is on the Electronic Options tab and in the Software Option box in the lower right. This feature is set to OFF at the factory.

Operations Modified:

Conflict Monitoring: When Flashing Yellow Arrow Enable and FYA for Channels 1-4 Use Yellow Drivers are both enabled, the Yellow of the permissive child channel will conflict with the conflicting

child channel if the flashing yellow arrow does not flash. When Flashing Yellow Arrow Enable is enabled and FYA for Channels 1-4 Use Yellow Drivers is disabled, the Green of the permissive child channel will conflict with the conflicting child channel if the flashing yellow arrow does not flash.

Dual Indication Monitoring: When Flashing Yellow Arrow Enable and FYA for Channels 1-4 Use Yellow Drivers are both ON (checked), the Yellow of the permissive child channel will be the indication that the monitor will use as the fourth input to be included in the parent channels dual indication testing. When Flashing Yellow Arrow Enable is ON and FYA for Channels 1-4 Use Yellow Drivers is OFF, the Green of the permissive child channel will be the indication that the monitor will use as the fourth input to be included in the parent channels dual indication testing.

Red Fail Monitoring: When Flashing Yellow Arrow Enable and FYA for Channels 1-4 Use Yellow Drivers are both ON (checked), the Yellow of the permissive child channel will be the indication that the monitor will use as the fourth input to be included in the parent channels red fail testing. When Flashing Yellow Arrow Enable is ON and FYA for Channels 1-4 Use Yellow Drivers is OFF, the Green of the permissive child channel will be the indication that the monitor will use as the fourth input to be included in the parent channels red fail testing.

Short Yellow Monitoring: When Flashing Yellow Arrow Enable and FYA for Channels 1-4 Use Yellow Drivers are ON, the Yellow of the permissive child channel will be monitored for a short or skipped yellow that must be timed on the parent channel. When Flashing Yellow Arrow Enable is ON and FYA for Channels 1-4 Use Yellow Drivers is OFF, the Green of the permissive child channel will be monitored for a short or skipped yellow that must be timed on the parent channel.

Short Clearance Monitoring: When Flashing Yellow Arrow Enable and FYA for Channels 1-4 Use Yellow Drivers are ON, the Yellow of the permissive child channel will be monitored for a short clearance fault. When Flashing Yellow Arrow Enable is ON and FYA for Channels 1-4 Use Yellow Drivers is OFF, the Green of the permissive child channel will be monitored for a short clearance fault.

Typical Use: If the yellow of a pedestrian channel or an overlap channel will be used to drive the flashing yellow arrow displays, turn this feature ON. In most applications, this feature and the FYA for Channels 5-18 Use Yellow Drivers are set to the same value. Having these two not be the same is useful in cabinets where the Green and the Yellow of the same channel are used to drive two different Flashing Yellow Arrow displays. A typical configuration would have the channel 9 Green driving the flashing yellow arrow for the channel 1 left turn, channel 10 Green driving the flashing yellow arrow for the channel 3 left turn, channel 9 Yellow driving the flashing yellow arrow for the channel 5 left turn, and channel 10 Green driving the flashing yellow arrow for the channel 7 left turn.

2.6.4.3 FYA FOR CHANNELS 5-18 USE YELLOW DRIVERS (FYA 5-18 USES YEL)

Configuration: This feature is only effective if Flashing Yellow Arrow Enable (Option Switch 2 – FYA EN) is active. If any of channels 5 through 18 will be a parent (the protected display) channel for a Flashing Yellow Arrow head, this feature is used to select which driver from the permissive child (the permissive display) channel will be used to make up the four sections of the Flashing Yellow Arrow head. ON (checked) indicates that the Yellow of the child channel will be used. OFF (unchecked) indicates that the Green of the child channel will be used. This feature can only be modified through the use of the RaeComM software and a computer or laptop. In the RaeComM software click on the wrench icon or on the menu choose Config / Monitor Configuration. This feature is on the Electronic Options tab and in the Software Option box in the lower right. This feature is set to OFF at the factory.

Operations Modified:

Conflict Monitoring: When Flashing Yellow Arrow Enable and FYA for Channels 5-18 Use Yellow Drivers are both enabled, the Yellow of the permissive child channel will conflict with the conflicting child channel if the flashing yellow arrow does not flash. When Flashing Yellow Arrow Enable is enabled and FYA for Channels 5-18 Use Yellow Drivers is disabled, the Green of the permissive child channel will conflict with the conflicting child channel if the flashing yellow arrow does not flash.

Dual Indication Monitoring: When Flashing Yellow Arrow Enable and FYA for Channels 5-18 Use Yellow Drivers are both ON (checked), the Yellow of the permissive child channel will be the indication that the monitor will use as the fourth input to be included in the parent channels dual indication testing. When Flashing Yellow Arrow Enable is ON and FYA for Channels 5-18 Use Yellow Drivers is OFF, the Green of the permissive child channel will be the indication that the monitor will use as the fourth input to be included in the parent channels dual indication testing.

Red Fail Monitoring: When Flashing Yellow Arrow Enable and FYA for Channels 5-18 Use Yellow Drivers are both ON (checked), the Yellow of the permissive child channel will be the indication that the monitor will use as the fourth input to be included in the parent channels red fail testing. When Flashing Yellow Arrow Enable is ON and FYA for Channels 5-18 Use Yellow Drivers is OFF, the Green of the permissive child channel will be the indication that the monitor will use as the fourth input to be included in the parent channels red fail testing.

Short Yellow Monitoring: When Flashing Yellow Arrow Enable and FYA for Channels 5-18 Use Yellow Drivers are ON, the Yellow of the permissive child channel will be monitored for a short or skipped yellow that must be timed on the parent channel. When Flashing Yellow Arrow Enable is ON and FYA for Channels 5-18 Use Yellow Drivers is OFF, the Green of the permissive child channel will be monitored for a short or skipped yellow that must be timed on the parent channel.

Short Clearance Monitoring: When Flashing Yellow Arrow Enable and FYA for Channels 5-18 Use Yellow Drivers are ON, the Yellow of the permissive child channel will be monitored for a short clearance fault. When Flashing Yellow Arrow Enable is ON and FYA for Channels 5-18 Use Yellow Drivers is OFF, the Green of the permissive child channel will be monitored for a short clearance fault

Typical Use: If the yellow of a pedestrian channel or an overlap channel will be used to drive the flashing yellow arrow displays, turn this feature ON. In most applications, this feature and the FYA for Channels 1-4 Use Yellow Drivers are set to the same value. Having these two not be the same is useful in cabinets where the Green and the Yellow of the same channel are used to drive two different Flashing Yellow Arrow displays. A typical configuration would have the channel 9 Green driving the flashing yellow arrow for the channel 1 left turn, channel 10 Green driving the flashing yellow arrow for the channel 3 left turn, channel 9 Yellow driving the flashing yellow arrow for the channel 5 left turn, and channel 10 Green driving the flashing yellow arrow for the channel 7 left turn.

2.6.4.4 FLASHING YELLOW ARROW IGNORES YELLOW CONFLICT (FYA IGNORES YEL CONFLICT)

Configuration: This feature is only effective if Flashing Yellow Arrow Enable (Option Switch 2 – FYA EN) is active. This is a feature that can only be modified through the use of the RaeComM software and a computer or laptop. In the RaeComM software click on the wrench icon or on the menu choose Config / Monitor Configuration. This feature is on the Electronic Options tab and in the Software Option box in the lower right. This feature is set to OFF at the factory.

Operations Modified:

Conflict Monitoring: When Flashing Yellow Arrow Enable and Flashing Yellow Arrow Ignores Yellow Conflict are both enabled and a channel has two FYA child checked (one conflicting channel and one permissive channel), the conflict between the Yellow arrow (parent channel Yellow) used to terminate a flashing Yellow arrow and the Yellow of the conflicting child (normally the opposing through Yellow ball) will be ignored. If the Yellow arrow is terminating the Green arrow of the parent channel, the Yellow arrow will still conflict with the conflicting child Yellow.

Typical Use: If it is desirable to terminate the flashing Yellow arrow display at the same time that the opposing through channel is terminating, the Yellow arrow to Yellow ball conflict that would normally occur during the clearance interval must be ignored. This feature allows that conflict to be ignored.

2.6.4.5 SPECIAL FUNCTION 2 ENABLE

Configuration: This is a feature that can only be modified through the use of the RaeComM software and a computer or laptop. In the RaeComM software click on the wrench icon or on the menu choose Config / Monitor Configuration. This feature is on the Electronic Options tab and in the Software Option box in the lower right. This feature is set to OFF at the factory.

Operations Modified:

Red Fail Monitoring: When Special Function 2 Enable is active, red fail monitoring can be disabled by activating the Special Function 2 input. To determine the active state for the Special Function 2 input, see Special Function 2 Invert 2.6.1.5

Typical Use: If a pre-emption sequence will show a field display that may cause a red fail fault and this is the desired operation, the Special Function 2 input can be used to force the monitor to ignore this fault condition during this pre-emption.

2.6.4.6 FORCE WATCHDOG TO 1500 MILLISECONDS (FORCE WD 1500 MSEC)

Configuration: This feature is only effective if the 2010 mode of operation (Option Switch 7 – 2010) is active. This is a feature that can only be modified through the use of the RaeComM software and a computer or laptop. In the RaeComM software click on the wrench icon or on the menu choose Config / Monitor Configuration. This feature is on the Electronic Options tab and in the Software Option box in the lower right. This feature is set to OFF at the factory.

Operations Modified:

Watchdog Monitoring: When Force Watchdog to 1500 Milliseconds is enabled and the 2010 mode of operation is enabled the Watchdog timer threshold will be forced to 1500 milliseconds instead of the 1000 milliseconds normally used.

Typical Use: If the 2070 controller does not stroke the Watchdog faster than once a second, this feature should be enabled.

2.6.4.7 DISABLE BUZZER

Configuration: This is a feature that can only be modified through the use of the RaeComM software and a computer or laptop. In the RaeComM software click on the wrench icon or on the menu choose Config / Monitor Configuration. This feature is on the Electronic Options tab and in the Software Option box in the lower right. This feature is set to OFF at the factory.

Operations Modified:

Configuration Monitoring: When Disable Buzzer is enabled, a pending configuration change will not be accompanied with a 1Hz audible buzzer. The buzzer can not be disable for major diagnostic faults.

Typical Use: While using the monitor in an office or shop area, and making many changes to the configuration of the monitor, it may be desirable to disable the buzzer as to not annoy others working around you. The buzzer should always be enabled when a monitor is deployed in the field.

2.6.4.8 DAYLIGHT SAVINGS TIME

Configuration: This is a feature that can only be modified through the use of the RaeComM software and a computer or laptop. In the RaeComM software click on the wrench icon or on the menu choose Config / Monitor Configuration. This feature is on the Electronic Options tab and in the Software Option box in the lower right. This feature can also be changed by clicking on the clock icon or on the menu choose Config / Date & Time. The actual points in time when the adjustments occur can also be viewed or changed on this screen. This feature is set to OFF at the factory.

Operations Modified:

Real Time Clock: When this feature is enabled the Real Time Clock will be adjusted according to the currently programmed Daylight Saving Time settings for Spring Ahead and Fall Back.

Typical Use: Any location that observes Daylight Saving Time.

2.7 EVENT LOGGING

Six different Event Logs provide detailed, date and time stamped documentation of selected events recorded by the monitor. This data is useful in troubleshooting and provides an accurate historical record of cabinet operation. When the date and time are not available through Port 1, the monitor will use its internal Real Time Clock as a date / time stamp for events.

2.7.1 TIME CHANGE LOG

The Time Change Log records the 50 most recent time changes. Data recorded: Original Date / Time Stamp, New Date / Time Stamp, and Up Time Accumulator.

2.7.2 MONITOR RESET LOG

The monitor Reset Log records the 20 most recent resets. Data recorded: Date / Time Stamp, Faults at Time of Reset, and Source of Reset (Front Panel, External, or Power Loss).

2.7.3 CONFIGURATION EVENT LOG

The Configuration Event Log records the ten most recent configuration changes. Data recorded: Date / Time Stamp, Channel Compatibility, Program Card Jumpers, Printed Circuit Board DIP Switch Settings, Type of Program Card, Factory Options set through RaeComM, and User Options set through RaeComM.

2.7.4 PRIOR FAULTS LOG

The Prior Faults Log records the 20 most recent faults. Data recorded: Date / Time Stamp; Cabinet Temperature; Faults Reported; Status of all Greens, Yellows, Reds, and Walks; Status of all DC Inputs; Status of Red Enable; Entire Front Panel Fault Display; AC Line Voltage; and Red Enable Voltage.

2.7.5 AC LINE LOG

The AC Line Log records the 50 most recent changes in AC line status. Data recorded: Date / Time Stamp, Event Type (Power Up / Reset, Low Voltage, Low Voltage Recovery, Shutdown, Low Voltage Alarm, Low Voltage Alarm Recovery, High Voltage Alarm, and High Voltage Alarm Recovery), and AC Line Voltage.

Through RaeComM, the user can adjust the High Voltage Alarm point and the Low Voltage Alarm point. These alarm points have a fixed, three volt hysteresis. Therefore, setting the High Voltage Alarm point to 135 volts will cause the recovery point to be set to 132 volts. Likewise, setting the Low Voltage Alarm point to 105 volts will cause the recovery point to be 108 volts. The factory defaults for these alarm points are 105 volts for the low alarm point and 135 volts for the high alarm point. *NOTE: The log will only record when these points are crossed. The minimum and maximum voltages seen are not recorded.*

2.7.6 SIGNAL SEQUENCE LOG

The Signal Sequence Log can be configured to record events occurring prior to a fault in one of two different modes.

Event Mode: The Signal Sequence Log records the 60 most recent events preceding the failure. An event is defined as an instance when any AC or DC signal, except for the Watchdog input, changes state. The monitor checks all inputs for changes in state every 33 milliseconds for the purpose of accumulating data for this log. Data recorded: Time Prior to Fault; Status and voltage of all Greens, Yellows, and Reds; status and voltage of all DC inputs; status and voltage of Red Enable; status and voltage of AC Line; and status and voltage of Special Function 1 & 2.

Time Mode: The Signal Sequence Log records the 2 seconds preceding the failure. The monitor records all inputs every 33 milliseconds for the purpose of accumulating data for this log. Data recorded: Time Prior to Fault; Status and voltage of all Greens, Yellows, and Reds; status and voltage of all DC inputs; status and voltage of Red Enable; status and voltage of AC Line; and status and voltage of Special Function 1 & 2.

2.8 DIAGNOSTICS

The Model 2018E unit incorporates a 16-bit microprocessor as the main processing unit, a 16-bit digital signal processor (DSP), and two 8-bit microcontrollers. The main microprocessor can be upgraded via the front panel communications port. The DSP and the two microcontrollers are flash based and can be reprogrammed in circuit.

One of the microcontrollers is dedicated to monitoring diagnostic signals from the other microcontroller, the DSP, and the main microprocessor. This microcontroller holds the main microprocessor in the reset state until the AC Line voltage and all supply voltages have been verified as being within operational ranges.

The monitor has an internal buzzer that stays on to indicate when the main microprocessor is not running. This will only occur very briefly during power up, 1.5 seconds after loss of AC power, and during major diagnostic failures.

The monitor is provided with a series of resident self-check diagnostics capabilities. When a fault is detected, the monitor transfers the Output relay contacts to the fault condition and illuminates the front panel **DIAG FAIL** LED. Diagnostic failures are latched in the fault condition until the unit is reset by the activation of the front panel reset switch or activation of the Reset input. A diagnostic failure is not reset by a monitor Power Failure.

2.8.1 MEMORY

The monitor verifies all memory elements on power up or upon reset of a Diagnostics failure. A failure of any of the memory tests will generate a diagnostics failure.

RAM Diagnostics: Test patterns are written to every byte of RAM in the monitor. After each write a read is performed to verify that the pattern is correct.

Program Flash Memory Diagnostics: A checksum is calculated for the entire program in the monitor. The calculated value is compared to a preprogrammed value stored in the Flash memory.

Configuration & Logging Flash Memory Diagnostics: A checksum is calculated for all of the configuration data and logging data stored in Flash memory in the monitor. The calculated value is compared to the value that was written to Flash memory during the last power down.

The monitor continues to verify the checksums of the Program memory and the Configuration & Logging memory during normal operation. Checksums are calculated for each type of memory at a rate of at least 1024 bytes per second.

2.8.2 MICROPROCESSOR MONITOR

The monitor continuously checks the operation of its microprocessor. The monitoring circuit receives a signal or logic state transition at least once every 33 milliseconds from the main microprocessor. When the signal or logic state transition is not received for more than 50 milliseconds a diagnostics fault is generated.

2.8.3 INTERNAL VOLTAGE MONITORS

The monitor checks the voltage levels of the internal DC power supplies. The +12 volt, +5 volt, +3.3 volt, and -3.3 volt power supplies are all monitored for proper voltage levels. When any of these voltage levels is invalid for more than programmed time a diagnostics fault is generated. These faults will not be logged by the monitor, as any one of these voltages being invalid will immediately place the monitor in a diagnostic failure mode with the microprocessor held in reset. This prevents any false faults or missed faults due to an internal power supply malfunction.

2.8.4 LED DISPLAY TEST

All of the LEDs on the front panel can be illuminated by pressing the front panel reset switch or activating the Reset input. When the reset switch is pressed or the Reset input activated, all of the LEDs will illuminate for 300 milliseconds. This allows the user to ensure that all displays are functioning correctly.

A more comprehensive test of the front panel LEDs is available through the RaeComM software. This testing will sequence through a preprogrammed sequence of test patterns.

2.8.5 DIAGNOSTIC CODES

When a fault is detected, the monitor transfers the Output relay contacts to the fault condition and illuminates the front panel **DIAG FAIL** LED. The channel LEDs will also begin to flash a binary representation of the diagnostic code. The diagnostic code may be viewed with RaeComM on the Real Time Status display.

FAULT	CHANNEL	CODE	DESCRIPTION OF FAULT
Code Checksum	1	0001h	The checksum calculated for the main code no longer matches the stored value.
Configuration Checksum	2	0002h	The checksum calculated for the configuration and logging data does not match the stored value.
Flash Write Error	3	0004h	A write to Flash memory did not complete normally.
RAM Error	4	0008h	A RAM location failed to read back the test pattern written to it.
DSP Timeout	5	0010h	The DSP did not respond to a request for data in the required amount of time.
DC Processor Timeout	6	0020h	The DC processor did not respond to a request for data in the required amount of time.
Temperature Timeout	7	0040h	The temperature sensor did not respond to a request for data in the required amount of time.
RTC Timeout	8	0080h	The Real Time Clock did not respond to a request for data in the required amount of time.
Task Watchdog Timeout	9	0100h	One or more of the tasks did not complete in its allotted time.
LED Shift Error	10	0200h	The front panel LED shift chain could not shift a bit through the entire chain.
UNUSED	11	0400h	
DIP Switch Shift Error	12	0800h	The PCB DIP switch shift chain could not shift a bit through the entire chain.
Program Card Shift Error	13	1000h	The Program Card shift chain could not shift a bit through the entire chain.
Program Card Read	14	2000h	The program card could not be read reliably. Bad solder joints on the program card jumpers commonly cause this error.
DSP Diagnostic Error	15	4000h	The DSP is indicating that it has a diagnostic error.
During the Boot Process	16	8000h	The fault identified above was found during the boot process.

Section 3 Specifications

3.1 PHYSICAL

WEIGHT: 20.7 oz. (587 gm).

SIZE: 9.300 inches (23.62 cm) high x 1.375 inches (3.49 cm) wide x 11.125 inches (28.26 cm) deep including connectors and card ejectors and handle.

STORAGE TEMPERATURE: -50° F to +185° F (-45° C to +85° C).

OPERATING TEMPERATURE: -30° F to +165° F (-34° C to +74° C).

HUMIDITY RANGE: 0 to 95% (relative).

CIRCUIT BOARDS: Printed circuit boards are 0.062 inch thick NEMA FR-4 glass epoxy with 2 oz. copper on both sides and plated through holes. Circuit boards and components are conformal coated with polyurethane.

CONNECTORS: (See Sections 3.4 to 3.6 for connector pin assignments.)

REAR EDGE CONNECTOR: 2 x 28 gold plated contact edge card connector with 0.156 inch (0.396 cm) contact centers. Key slot located between 17/U & 18/V.

RED INTERFACE CONNECTOR: 20 pin, right angle, male connector with latching clip locks and polarizing keys. 3M p/n 3428-5302 or equivalent.

COM PORT CONNECTOR: Mini USB B, 5 pin, female contacts.

ETHERNET CONNECTOR: High speed, 10Base-T / 100Base-TX - RJ-45 network jack.

3.2 ELECTRICAL

POWER: 85 to 135 VAC, 60 Hz \pm 4Hz, 6 watts (nominal).

AC VOLTAGE INPUTS:

Normal AC Power Thresholds: Dropout.....	< 98V _{RMS}	Restore.....	> 103V _{RMS}
Low AC Power Thresholds: Dropout.....	< 92V _{RMS}	Restore.....	> 98V _{RMS}
AC Line Frequency: Dropout.....	< 56Hz or > 64Hz	Restore>	57.5Hz and < 62.5Hz
MC Coil (Pin EE): OFF	< 50V _{RMS}	ON	> 70V _{RMS}

AC VOLTAGE INPUTS (INCANDESCENT DISPLAY THRESHOLDS):

THRESHOLDS USED FOR ALL TESTS:

Green Signal Inputs: OFF	< 15V _{RMS}	ON	> 25V _{RMS}
Yellow Signal Inputs: OFF	< 15V _{RMS}	ON	> 25V _{RMS}
Red Signal Inputs: OFF	< 50V _{RMS}	ON	> 70V _{RMS}
Red Enable Input: OFF	< 50V _{RMS}	ON	> 70V _{RMS}
Special Function Inputs: OFF	< 50V _{RMS}	ON	> 70V _{RMS}

AC VOLTAGE INPUTS (LED DISPLAY THRESHOLDS):

THRESHOLDS FOR CONFLICT AND MULTIPLE INDICATION TESTS:

Green Signal Inputs: OFF	< 15V _{RMS}	ON	> 25V _{RMS}
Yellow Signal Inputs: OFF	< 15V _{RMS}	ON	> 25V _{RMS}
Red Signal Inputs: OFF	< 15V _{RMS}	ON	> 25V _{RMS}
Red Enable Input: OFF	< 50V _{RMS}	ON	> 70V _{RMS}
Special Function Inputs: OFF	< 50V _{RMS}	ON	> 70V _{RMS}

THRESHOLDS FOR RED FAIL, SHORT YELLOW, AND SHORT CLEARANCE TESTS:

Green Signal Inputs: OFF	< 50V _{RMS}	ON	> 70V _{RMS}
Yellow Signal Inputs: OFF	< 50V _{RMS}	ON	> 70V _{RMS}
Red Signal Inputs: OFF	< 50V _{RMS}	ON	> 70V _{RMS}
Red Enable Input: OFF	< 50V _{RMS}	ON	> 70V _{RMS}
Special Function Inputs: OFF	< 50V _{RMS}	ON	> 70V _{RMS}

DC VOLTAGE INPUTS:

+24VDC Input Low: Fault.....	< +18V _{DC}	No Fault.....	> +22V _{DC}
+24VDC Input High: Fault.....	> +30V _{DC}	No Fault.....	< +28V _{DC}
+24VDC Input Ripple: Fault.....	> 1.25V _{RMS}	No Fault.....	< 0.75V _{RMS}

LOGIC INPUTS:

Reset Input: True	< +4V _{DC}	False	> +12V _{DC}
Watchdog Timer: True	< +4V _{DC}	False	> +12V _{DC}

3.3 TIMING FUNCTIONS

210 MODE OF OPERATION:

+24 VDC LOW:	No Fault.....< 200 ms	Detect,> 500 ms	Typical..... 350 ms
+24 VDC HIGH:	No Fault.....< 200 ms	Detect,> 500 ms	Typical..... 350 ms
+24 VDC RIPPLE:	No Fault.....< 750 ms	Detect,> 1250 ms	Typical..... 1000 ms
FRONT PANEL RESET:	Ignore,< 50 ms	Respond,> 75 ms	Typical..... 60 ms
EXTERNAL RESET:	Ignore,< 50 ms	Respond,> 75 ms	Typical..... 60 ms
WATCHDOG TIMER:	No Fault.....< 1400 ms	Detect,> 1600 ms	Typical..... 1500 ms
WATCHDOG START UP:	Ignore all State Changes on Start Up.....4 sec		
WATCHDOG COUNT:	Transitions before Exiting Start Up Flash 0 transitions		
WATCHDOG MAX START:	No Fault.....< 9.5 sec	Fault.....> 10.5 sec	Typical.....10 sec
MONITOR POWER FAIL:	Ignore,< 66 ms	Respond,> 100 ms	Typical..... 83 ms
STOP TIME:	Released Prior to Return from Flash0 ms		
RED ENABLE:	Ignore,< 75 ms	Respond,> 125 ms	Typical.....100 ms
MC COIL (PIN EE):	Ignore,< 250 ms	Respond,> 550 ms	Typical..... 400 ms
SPECIAL FUNCTIONS:	Ignore,< 250 ms	Respond,> 550 ms	Typical..... 400 ms
RESET LOCK OUT:	No Fault.....< 400 ms	Detect,> 600 ms	Typical..... 500 ms
CONFLICT:	No Fault.....< 200 ms	Detect,> 450 ms	Typical..... 333 ms
RED FAIL:	No Fault.....< 700 ms	Detect,> 1000 ms	Typical..... 800 ms
RED ENABLE FAIL:	No Fault.....< 700 ms	Detect,> 1000 ms	Typical..... 800 ms
YELLOW FAIL:	No Fault.....< 2.8 sec	Detect,> 2.6 sec	Typical.....2.7 sec
MULTI INDICATION:	No Fault.....< 200 ms	Detect,> 500 ms	Typical..... 350 ms
FLASHING DON'T WALK:	No Fault.....< 1400 ms	Respond,>1600 ms	Typical..... 1500 ms
	Flashing if state changes are > 200 ms and < 600 ms Typical..... 500 ms		

2010 MODE OF OPERATION:

+24 VDC LOW:	No Fault.....< 200 ms	Detect,> 500 ms	Typical..... 350 ms
+24 VDC HIGH:	No Fault.....< 200 ms	Detect,> 500 ms	Typical..... 350 ms
+24 VDC RIPPLE:	No Fault.....< 750 ms	Detect,> 1250 ms	Typical..... 1000 ms
FRONT PANEL RESET:	Ignore,< 50 ms	Respond,> 75 ms	Typical..... 60 ms
EXTERNAL RESET:	Ignore,< 50 ms	Respond,> 75 ms	Typical..... 60 ms
WATCHDOG TIMER:	No Fault.....< 900 ms	Detect,> 1100 ms	Typical..... 1000 ms
WATCHDOG START UP:	Ignore all State Changes on Start Up.....4 sec		
WATCHDOG COUNT:	Transitions before Exiting Start Up Flash 5 transitions		
WATCHDOG MAX START:	No Fault.....< 9.5 sec	Fault.....> 10.5 sec	Typical.....10 sec
MONITOR POWER FAIL:	Ignore,< 350 ms	Respond,> 450 ms	Typical..... 400 ms
STOP TIME:	Released Prior to Return from Flash 250 ms		
RED ENABLE:	Ignore,< 75 ms	Respond,> 125 ms	Typical.....100 ms
MC COIL (PIN EE):	Ignore,< 250 ms	Respond,> 550 ms	Typical..... 400 ms
SPECIAL FUNCTIONS:	Ignore,< 250 ms	Respond,> 550 ms	Typical..... 400 ms
RESET LOCK OUT:	No Fault.....< 400 ms	Detect,> 600 ms	Typical..... 500 ms
CONFLICT:	No Fault.....< 200 ms	Detect,> 450 ms	Typical..... 333 ms
RED FAIL:	No Fault.....< 1200 ms	Detect,> 1500 ms	Typical.....1300 ms
RED ENABLE FAIL:	No Fault.....< 1200 ms	Detect,> 1500 ms	Typical.....1300 ms
YELLOW FAIL:	No Fault.....< 2.8 sec	Detect,> 2.6 sec	Typical.....2.7 sec
MULTI INDICATION:	No Fault.....< 200 ms	Detect,> 500 ms	Typical..... 350 ms
FLASHING DON'T WALK:	No Fault.....< 1400 ms	Respond,>1600 ms	Typical..... 1500 ms
	Flashing if state changes are > 200 ms and < 600 ms Typical..... 500 ms		

3.4 TABLE: REAR EDGE CONNECTOR PIN ASSIGNMENTS

Pin	Function (Back Side)	I/O	Pin	Function (Component Side)	I/O
1	Channel 2 Green	I	A	Channel 2 Yellow	I
2	Channel 13 Green	I	B	Channel 6 Green	I
3	Channel 6 Yellow	I	C	Channel 15 Green	I
4	Channel 4 Green	I	D	Channel 4 Yellow	I
5	Channel 14 Green	I	E	Channel 8 Green	I
6	Channel 8 Yellow	I	F	Channel 16 Green	I
7	Channel 5 Green	I	H	Channel 5 Yellow	I
8	Channel 13 Yellow	I	J	Channel 1 Green	I
9	Channel 1 Yellow	I	K	Channel 15 Yellow	I
10	Channel 7 Green	I	L	Channel 7 Yellow	I
11	Channel 14 Yellow	I	M	Channel 3 Green	I
12	Channel 3 Yellow	I	N	Channel 16 Yellow	I
13	Channel 9 Green	I	P	Channel 17 Yellow	I
14	Channel 17 Green	I	R	Channel 10 Green	I
15	Channel 11 Yellow	I	S	Channel 11 Green	I
16	Channel 9 Yellow	I	T	Channel 18 Yellow	I
17	Channel 18 Green	I	U	Channel 10 Yellow	I
--			--		
18	Channel 12 Yellow	I	V	Channel 12 Green	I
19	Channel 17 Red	I	W	Channel 18 Red	I
20	Chassis Ground	I/O	X	Not Assigned	
21	AC -	I	Y	DC Ground	I
22	Watchdog Timer	I	Z	External Reset	I
23	24 VDC	I	AA	24VDC	I
24	Tied to Pin 25	I/O	BB	Stop Time	O
25	Tied to Pin 24	I/O	CC	Not Assigned	
26	Not Assigned		DD	Not Assigned	
27	Not Assigned		EE	Relay Output, Side 2	I/O
28	Relay Output, Side 1	I/O	FF	AC +	I

-- Slotted for keying between Pins 17/U and 18/V.

3.6 TABLE: FRONT PANEL CONNECTORS PIN ASSIGNMENTS

Red Interface Connector

Pin	Function	I/O
1	Channel 15 Red	I
2	Channel 16 Red	I
3	Channel 14 Red	I
4	Chassis Ground	I/O
5	Channel 13 Red	I
6	Special Function 2	I
7	Channel 12 Red	I
8	Special Function 1	I
9	Channel 10 Red	I
10	Channel 11 Red	I
11	Channel 9 Red	I
12	Channel 8 Red	I
13	Channel 7 Red	I
14	Channel 6 Red	I
15	Channel 5 Red	I
16	Channel 4 Red	I
17	Channel 3 Red	I
18	Channel 2 Red	I
19	Channel 1 Red	I
20	Red Enable	I

COMM Port Connector

Pin	Function	I/O
1	No Connection	
2	TX Data	I
3	RX Data	O
4	No Connection	
5	Ground	I/O
6	No Connection	
7	No Connection	
8	No Connection	
9	No Connection	

NOTE: Keying provided between pins 3 and 5, and between pins 17 and 19.

3.7 TABLE: PROGRAMMING CARD PIN ASSIGNMENTS

Pin	Function (Back Side)
1	Channel 2 Green
2	Channel 3 Green
3	Channel 4 Green
4	Channel 5 Green
5	Channel 6 Green
6	Channel 7 Green
7	Channel 8 Green
8	Channel 9 Green
9	Channel 10 Green
10	Channel 11 Green
11	Channel 12 Green
12	Channel 13 Green
13	Channel 14 Green
14	Channel 15 Green
15	Channel 16 Green
16	Programming Card Ajar
17	Channel 1 Yellow
18	Channel 2 Yellow
19	Channel 3 Yellow
20	Channel 4 Yellow
21	Channel 5 Yellow
22	Channel 6 Yellow
23	Channel 7 Yellow
24	Channel 8 Yellow
--	
25	Channel 17 Green
26	Channel 18 Green
27	Channel 16 Green
28	Yellow Inhibit Common

Pin	Function (Component Side)
A	Channel 1 Green
B	Channel 2 Green
C	Channel 3 Green
D	Channel 4 Green
E	Channel 5 Green
F	Channel 6 Green
H	Channel 7 Green
J	Channel 8 Green
K	Channel 9 Green
L	Channel 10 Green
M	Channel 11 Green
N	Channel 12 Green
P	Channel 13 Green
R	Channel 14 Green
S	Channel 15 Green
T	Programming Card Ajar
U	Channel 9 Yellow
V	Channel 10 Yellow
W	Channel 11 Yellow
X	Channel 12 Yellow
Y	Channel 13 Yellow
Z	Channel 14 Yellow
AA	Channel 15 Yellow
BB	Channel 16 Yellow
--	
CC	Channel 17 Yellow
DD	Channel 18 Yellow
EE	Programming Card Ajar
FF	Channel 17 Green

-- Slotted for keying between Pins 24/BB and 25/CC.

Section 4 User Interface

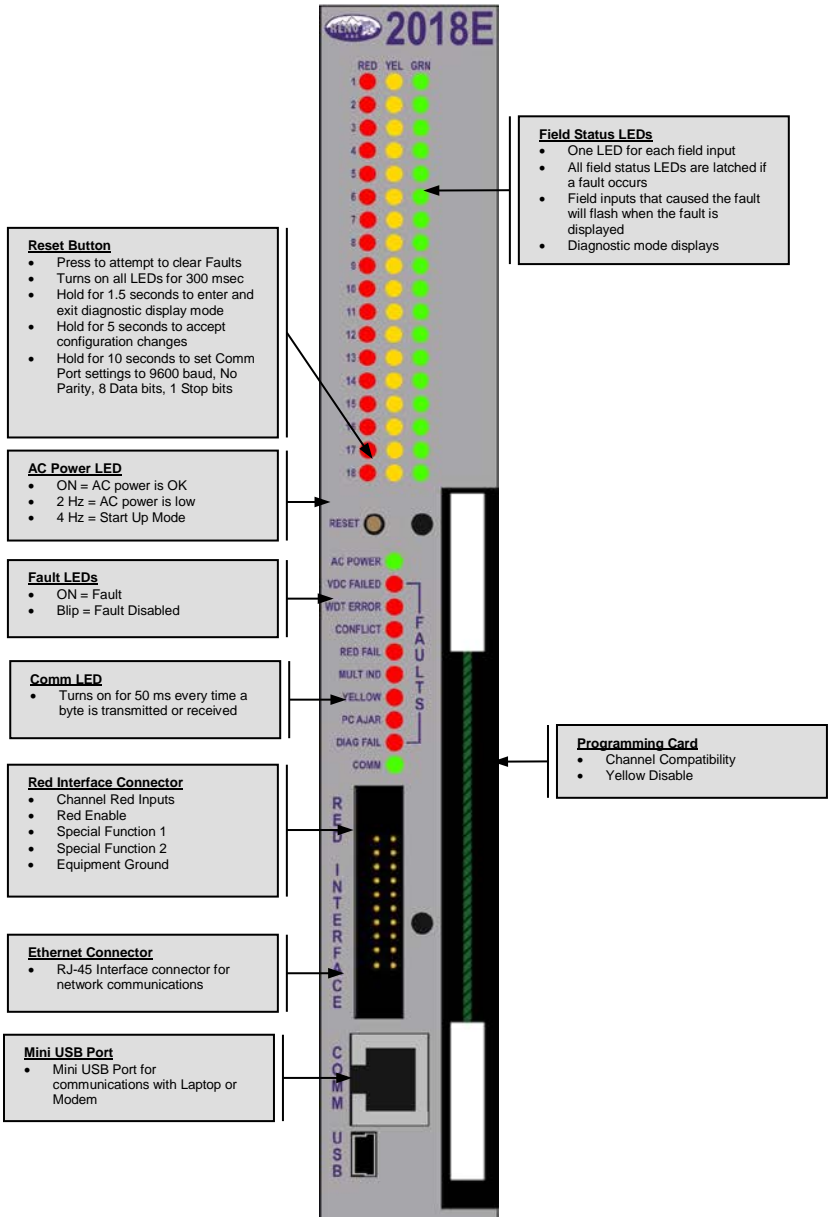

4.1 PRINTED CIRCUIT BOARD SWITCHES & JUMPERS

4.1.1 DUAL INDICATION ENABLE SWITCHES

Eighteen DIP switches on the PC board enable, on a per channel basis, Dual Indication monitoring. The switches, labeled DUAL ENABLE SWITCHES, are located near the upper left corner of the PC board. The numbers 1 through 18 correspond to the monitor channel that the switch affects. When a switch is ON, Dual Indication monitoring will occur for that channel. The factory default for the channel settings of this option is all channels disabled. For details on Dual Indication monitoring see Section [2.5.3](#).

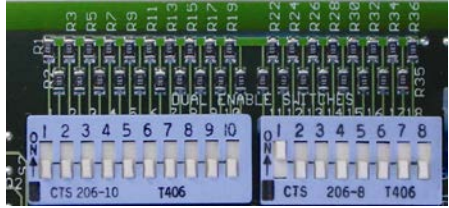

4.1.2 RED FAIL SWITCHES

Eighteen DIP switches on the PC board enable, on a per channel basis, Red Fail monitoring. The switches, labeled RED FAIL SWITCHES, are located near the upper right corner of the PC board. The numbers 1 through 18 correspond to the monitor channel that the switch affects. When a switch is ON, the monitor will only perform Red Fail monitoring for that channel when the Red Enable input is active. The factory default for the channel settings of this option is all channels enabled.

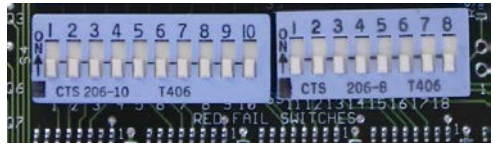

Only the Red Fail monitoring is affected by this feature. Other monitoring normally controlled by the Red Enable input (Short Yellow, Short Clearance, and Dual Indication) still operate as defined and are not affected in any way by the activation of this feature. For details on Red Fail monitoring see Section [2.5.2](#).

4.1.3 OPTION SWITCHES

Eight DIP switches on the PC board enable one or more of eight user selectable options. The switches, labeled OPTION SWITCHES, are located near the upper right corner of the PC board. The numbers 1 through 8 correspond to the option that the switch enables. When a switch is ON, then the option is enabled.

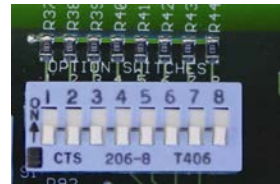

4.1.3.1 SWITCH 1 – FLASHING DON'T WALK MONITORING (DW MON)

When ON, the monitor will ensure that flashing Don't Walk displays do not conflict with other greens or yellows at the intersection. In order to use this feature the RaeComM software must be used to set the channels that this feature is enabled for. The factory default for this feature is no channels enabled.

When a fault is detected due to this feature, it is displayed as a CONFLICT and the channel with a flashing RED input that was involved in the detected fault will be flashing its RED LED. See Section [2.6.1.1](#) for more information.

To view the channels that will have flashing Don't Walk monitoring enabled, perform the following steps:

1. Press and hold the front panel **RESET** switch until 1 beep is heard to activate Diagnostic Display.
2. Tap the **RESET** switch two times to get to the C2 (Configuration Screen 2) display.
3. Red channel LEDs will display an ON for channels with this feature enabled.
4. Press and hold the front panel **RESET** switch until 1 beep is heard to return to normal operation.

NOTE: The monitor will continue to operate normally while in the diagnostic display mode. Any fault detected while in this mode will be displayed correctly when returned to normal operation.

4.1.3.2 SWITCH 2 – FLASHING YELLOW ARROW ENABLE (FYA EN)

When ON, the monitor will activate special internal logic to properly monitor a Flashing Yellow Arrow Protected/Permissive Left Turn. Refer to Application Note AN-005 for detailed examples of Flashing Yellow Arrow implementations.

The channel that will display the solid Red arrow, Yellow arrow, and Green arrow is the parent channel. It is necessary to define the conflicting through and the channel where the flashing Yellow arrow itself will be connected. See Section [2.6.1.2](#) for more information.

To view the Flashing Yellow Arrow settings for each channel perform the following steps:

1. Press and hold the front panel **RESET** switch until 1 beep is heard to activate the Diagnostic Display.
2. Tap the **RESET** switch two times to get to the C2 (Configuration Screen 2) display.
3. Press and hold the front panel **RESET** switch until 2 beeps are heard to activate FYA sub menu display.

4. Tap the **RESET** switch until the desired channel is displayed.
5. The displayed parent channel will have its Red, Yellow, and Green LEDs flashing. A solid Red LED indicates the conflicting channel (normally the opposing through channel). A solid Yellow or Green LED indicates where the Flashing Yellow Arrow should be connected. See Section **4.4.3.1** for more information.
6. Press and hold the front panel **RESET** switch until 1 beep is heard to return to normal operation.

NOTE: The monitor will continue to operate normally while in the diagnostic display mode. Any fault detected while in this mode will be displayed correctly when returned to normal operation.

4.1.3.3 SWITCH 3 - +24VDC ENHANCED MONITORING (24V ENH)

When ON, the monitor will also check the +24VDC input for over voltage (greater than 30V_{DC}) and excessive ripple (greater than 1V_{RMS}). When OFF, the standard +24VDC monitoring is selected.

When the Enhanced +24VDC Monitoring is enabled, the **VDC FAILED** indicator will flash at a 5 Hz rate when the +24VDC input is above 30V_{DC}. The indicator will flash at a 1 Hz rate when the ripple on the +24VDC input exceeds 1V_{RMS}. See Section **2.6.1.3** for more information.

4.1.3.4 SWITCH 4 – SPECIAL FUNCTION 1 INVERT (SF1 INV)

When ON, the monitor will sense the Special Function 1 input as active in the LOW state (less than 50V_{RMS}). The Special Function 1 input must remain in a state for at least 550 milliseconds to be recognized as in that state. See Section **2.6.1.4** for more information.

4.1.3.5 SWITCH 5 – SPECIAL FUNCTION 2 INVERT (SF2 INV)

When ON, the monitor will sense the Special Function 2 input as active in the LOW state (less than 50V_{RMS}). The Special Function 2 input must remain in a state for at least 550 milliseconds to be recognized as in that state. The *Special Func 2 Enable* user option in RaeComM must be selected in order for Special Function 2 to function. See Section **2.6.1.5** for more information.

4.1.3.6 SWITCH 6 – GY-DUAL INDICATION MONITORING (GY MON)

When ON, the monitor will check for simultaneously active Green and Yellow field signal inputs on the same channel. This feature will be active on all channels that do not have a Yellow Disable jumper installed on the Program Card and is not active if the RED ENABLE input is not active.

The GY Dual Indication Monitoring enable can be used in conjunction with the DUAL ENABLE switches on the circuit board. Channels that have their DUAL ENABLE switches ON will perform Dual Indication monitoring as described in Dual Indication Monitoring (Section **2.5.3**). Channels that have their DUAL ENABLE switches OFF will perform the GY Dual Indication Monitoring (Section **2.6.1.6**).

4.1.3.7 SWITCH 7 – 2010 MODE – 2010

When ON, the monitor will operate in the 2010 mode of operation. When OFF, the 210 mode of operation is selected. For a detailed description of the differences in these two modes see Section **2.6.1.7**.

4.1.3.8 SWITCH 8 – LED THRESHOLDS (LED THR)

The monitor can use the standard incandescent field display thresholds or enhanced LED field display thresholds. The active threshold is selected with Option switch 9. When Option switch 9 is OFF the standard incandescent field display thresholds are selected. When Option switch 9 is ON the enhanced LED field display thresholds are selected. For a detailed description of the difference in these two thresholds see Section **2.6.1.8**.

4.1.4 OPTION JUMPERS

There are four sets of jumper-hole pairs on the PC board that are used to enable one or more of four user selectable options. The jumper-hole pairs, labeled J2, are located in the upper center portion of the circuit board. The numbers 1 through 4 correspond to the option that the jumper enables. When a jumper is installed in one of the jumper-hole pairs, then the option corresponding to that jumper hole pair is enabled.

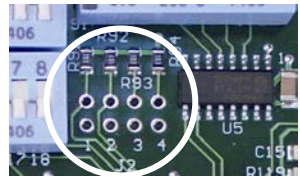

4.1.4.1 JUMPER 1 – DO NOT ALLOW 16 CHANNEL PROGRAM CARD (NO CH16)

When this jumper is installed, the monitor will not accept 16 channel Program Cards. When jumpered and a 16 channel Program Card is inserted, then the monitor will display a **PC AJAR** fault with all three field indications for channels 1 through 16 flashing. See Section **2.6.2.1** for more information.

4.1.4.2 JUMPER 2 – DO NOT ALLOW 18 CHANNEL PROGRAMM CARD (NO CH18)

When this jumper is installed, the monitor will not accept 18 channel Program Cards. When jumpered and an 18 channel Program Card is inserted, then the monitor will display a **PC AJAR** fault with all three field indications for channels 1 through 18 flashing. Also, when this feature is enabled, the channel 17 and 18 Red, Yellow, and Green field indications will not show the function disabled blip when a 16 channel Program Card is installed. See Section **2.6.2.2** for more information.

4.1.4.3 JUMPER 3 – RED ENABLE MUST BE ON (RED EN)

When this jumper is installed, the monitor will ensure that the Red Interface cable is plugged in. The monitor will generate a Red Fail fault whenever the Red Enable input is not active and channel 1 through 16 reds are all off. Special Function 1 and 2 inputs can be used to disable Red Fail monitoring, if needed. See Section 2.6.2.3 for more information.

4.1.4.4 JUMPER 4 – MULTIPLE INDICATION & SHORT YELLOW MONITORING ARE ALWAYS ON (MI/SY ON)

This feature is useful when the user wants to ensure that the Multiple Indication and Short Yellow monitoring are always active. These functions are normally disabled when the Red Enable input is not active. Installing Option jumper 4 enables this feature. When installed, the monitor will always perform Multiple Indication and Short Yellow monitoring. See Section 2.6.2.4 for more information.

4.1.5 WATCHDOG SWITCH

The Model 2018E monitor features a circuit board mounted, two-position toggle switch that can be used to enable the Watchdog Timer monitoring function. The toggle switch, labeled WATCHDOG, is located near the center of the circuit board just above the upper Programming Card guide. When the switch is set to the ENABLE position, the Watchdog Timer monitoring function is enabled. When the switch is set to the DISABLE position, the Watchdog Timer monitoring function is disabled. The factory default setting of this switch is ENABLE. See Section 2.5.7 for more information.

NOTE: The Model 2018E monitor can be factory configured without the Watchdog Timer switch. If the switch is not present, the monitor will operate with the Watchdog Timer monitoring function permanently enabled.

4.2 FRONT PANEL LED INDICATORS

The monitor has 64 light emitting diodes (LEDs) used to convey information to the user. These LEDs are color coded to increase view-ability and intuitiveness of the display. The LEDs used are ultra-bright to allow viewing of the front panel indicators in direct sunlight. The front panel display is updated every 16 milliseconds by the monitor.

4.2.1 FIELD STATUS INDICATORS

There are 54 field status indicators, one for each field input. The display is logically organized into three columns and eighteen rows. The columns are labeled **RED** for Red, **YEL** for Yellow, and **GRN** for Green indicators. The rows are numbered from 1 to 18, corresponding to the channel numbers.

The indicator for a field input will be on if the RMS voltage over the last 33 milliseconds is above the threshold for that type of input. See Section 2.1.4 for the voltage levels for each type of input.

When a fault is detected, the field status is latched and the field input involved in the detected fault will flash at a 5 Hz rate. The following table lists the information displayed on the Field Status indicators during the various fault conditions.

FAULT CONDITION	FIELD STATUS INDICATIONS
VDC FAILED WDT ERROR	<i>ON</i> - Field inputs that were ON for at least 33 ms at the time of the fault.
CONFLICT	<i>ON</i> - Field inputs that were ON for at least 33 ms at the time of the fault. <i>FLASHING</i> - Field inputs that were ON and were the cause of the fault.
RED FAIL	<i>ON</i> - Field inputs that were ON for at least 100 ms at the time of the fault. <i>FLASHING</i> - All field inputs for the channel(s) that had no display.
MULT IND	<i>ON</i> - Field inputs that were ON for at least 100 ms at the time of the fault. <i>FLASHING</i> - Field inputs that were ON and were the cause of the fault.
YELLOW	<i>ON</i> - Field inputs that were ON for at least 100 ms at the time of the fault. <i>FLASHING</i> - The Yellow field inputs on which a Short Yellow was detected. The Green field inputs that were not OFF for at least 2.7 seconds before a conflicting channel was detected as active.
PC AJAR	<i>ON</i> - Field inputs that were ON for at least 33 ms at the time of the fault. <i>FLASHING</i> - An invalid Program Card has been inserted.
DIAG FAIL	<i>FLASHING</i> - The diagnostic code for the internal fault. Channel 1 is bit 0 and Channel 16 is bit 15 of the diagnostic code in binary. NOTE: This may be incorrectly displayed depending on the type of failure being experienced.

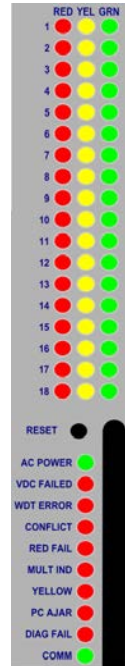

4.2.2 AC POWER INDICATOR

The green **AC POWER** indicator is on continuously when the AC line voltage is above 103V_{RMS} except while in the start up mode. This indicator will flash at a 4 Hz rate while in the start up mode and waiting for the Watchdog

Timer input to become valid. When the AC line voltage is below $98V_{RMS}$, the indicator will flash at a 2 Hz rate to indicate low line voltage. While the AC line voltage is low, all field status indicators will be off. Any active fault indicators will stay on. See Section 2.4.1 for details on Monitor Power Up / Power Recovery. See Section 2.4.2 for details on Monitor Power Failure detection. See Section 2.6.3.3 for details on Low AC Power Thresholds.

4.2.3 VDC FAILED INDICATOR

The red **VDC FAILED** indicator is used to indicate that the voltage at the +24VDC input is outside of the allowable operating range. The indicator will be on solid when the voltage on the +24VDC input is below $18V_{DC}$. See Section 2.5.6 for more information.

When Enhanced +24VDC Monitoring is enabled, this indicator will flash at a 5 Hz rate when the +24VDC input is above $30V_{DC}$. The indicator will flash at a 1 Hz rate when the ripple on the +24VDC input exceeds $1V_{RMS}$. See Section 2.6.1.3 for more information on +24VDC enhanced monitoring.

4.2.4 WDT ERROR INDICATOR

The red **WDT ERROR** indicator is used to indicate that a Watchdog fault has been detected on the Watchdog Timer input. See Section 2.5.7 for more information on a Watchdog fault.

4.2.5 CONFLICT INDICATOR

The red **CONFLICT** indicator is used to indicate that a Conflict fault has been detected on the field inputs. See Section 2.5.1 for more information on a Conflict fault.

4.2.6 RED FAIL INDICATOR

The red **RED FAIL** indicator is used to indicate that one or more channels of the monitor had no active field inputs (Red, Yellow, or Green). See Section 2.5.2 for more information on a Red Fail fault.

4.2.7 MULTI IND INDICATOR

The red **MULT IND** indicator is used to indicate that one or more channels of the monitor had more than one active field input (Red, Yellow, or Green). See Section 2.5.3 for more information on a Dual Indication fault.

4.2.8 YELLOW INDICATOR

The red **YELLOW** indicator is used to indicate that a Short Yellow or Short Clearance fault has been detected on the field inputs. See Section 2.5.4 for more information on a Short Yellow fault and Section 2.5.5 for more information on a Short Clearance fault.

4.2.9 PC AJAR INDICATOR

The monitor has a red LED labeled **PC AJAR** that is used to indicate that the Program Card is not installed, not seated properly, or that the inserted Program Card is not allowed. The latter can occur when the monitor is configured to not allow a specific type of Program Card and that type of card is inserted in to the monitor. See Section 2.5.8 for more information on a Program Card Absent fault. See Section 2.6.2.1 for more information on Do Not Allow 16 Channel Program Card and Section 2.6.2.2 for more information on Do Not Allow 18 Channel Program Card.

The **PC AJAR** indicator can also indicate a configuration setting has changed by flashing at a 1 Hz rate. No configuration changes are implemented until the front panel Reset switch is activated and held for five seconds. At that time, you will hear five short beeps, the new settings will be implemented, and a Configuration Change log entry made. See Section 2.4.8 for more information on configuration monitoring.

4.2.10 DIAG FAIL INDICATOR

The red **DIAG FAIL** indicator is used to indicate that a Diagnostic fault has been detected. See Section 2.8.4 for more information on Diagnostic codes.

This indicator is also used to alert the user to changes in the monitor code (firmware) that are presently under way or have been made and have yet to be implemented. The LED will flash at a 5 Hz rate to indicate that the monitor is currently receiving updated code. Once the updated code has been transferred, the 5 Hz flash rate will cease. The LED will flash at a 1 Hz rate to indicate a pending code change (i.e. new code has been downloaded but not implemented). Once power to the monitor has been cycled off and on, the code change will be implemented and the 1 Hz flash rate will cease.

4.2.11 COMM INDICATOR

The **COMM** indicator turns on for 50 milliseconds every time a byte of data is transmitted or received by the monitor. See Section 2.4.4 for more information on the serial communications port.

4.2.12 FUNCTION DISABLED INDICATION

When a function has been disabled, the associated indicator will turn on for 50 milliseconds once every two seconds.

Functions may be disabled for one of several different reasons:

INDICATOR	DISABLE CONDITIONS
WDT ERROR	The circuit board switch labeled WATCHDOG is in the DISABLE position.
CH 17 & CH 18	A 16-channel Program Card is inserted in the monitor.
RED FAIL	The Red Enable input (Red Interface Connector - Pin a) is below $70V_{RMS}$. The MC Coil input (Rear Edge Connector - Pin EE) is below $70V_{RMS}$. Special Function 1 input (Red Interface Connector - Pin 8) is active. Special Function 2 input (Red Interface Connector - Pin 6) is active.
MULT IND	The Red Enable input (Red Interface Connector - Pin a) is below $70V_{RMS}$.
YELLOW	The Red Enable input (Red Interface Connector - Pin a) is below $70V_{RMS}$.

4.3 AUDIBLE BUZZER

The monitor is equipped with an audible buzzer. This buzzer is used to bring important events to the attention of the user. The buzzer can be disabled for pending configuration notifications only. This can only be done through the RaeComM software under CONFIG > MONITOR CONFIGURATION > ELECTRONIC OPTIONS.

4.3.1 CRITICAL FAILURE

When the monitor main microprocessor is held in the reset state due to a critical hardware failure, the buzzer will stay on constantly. There is no way to disable this indication, as it is an indication that the monitor is not operational.

4.3.2 CONFIGURATION CHANGE

The monitor checks for configuration changes every second. A configuration change is defined as a change of any of the following parameters:

- Programming Card diodes and jumpers
- Program Card Type (16 or 18 Channel)
- Printed circuit board switches and jumpers
- Factory Setup Options set through the RaeComM software
- Software Options set through the RaeComM software

If a configuration change is identified, the monitor will enter a configuration fault mode and the audible buzzer will start to beep at a one second rate. This is an indication that a change to the current configuration has been identified. The monitor does not implement any configuration changes until the front panel **RESET** switch is activated and held for five seconds. At that time the buzzer will chirp five times then stop beeping. If the configuration parameters that were changed are restored to their original states, the buzzer will stop beeping but the **RESET** switch will have to be pressed to return from the fault state.

*NOTE: If power is removed from the monitor prior to the configuration changes being accepted by pressing the **RESET** switch, the pending changes will still be pending and the original settings will be used on power up.*

4.4 DIAGNOSTIC DISPLAY MODE

The monitor supports a diagnostic display mode that allows the user to view the current line voltage, active configurations settings, and past faults. This information is viewed on the field status indicators and the fault indicators. The display identifier will be displayed for 0.5 seconds followed by the data for 2.5 seconds. This display sequence will be repeated as long as the diagnostic display mode is active.

To display the Ethernet IP address, press and hold the front panel **RESET** pushbutton for more than 3 seconds but less than 5 seconds. The buzzer will emit a single chirp when 1.5 seconds have elapsed and two chirps when 3 seconds have elapsed. This is an audible cue to release the **RESET** pushbutton to view the Ethernet IP address. To exit the diagnostic display mode, repeat the procedure used to enter the mode.

To enter the diagnostic display mode, press and hold the front panel **RESET** pushbutton for more than 1.5 seconds but less than three seconds. The buzzer will emit a single chirp when 1.5 seconds have elapsed. This is an audible cue to release the **RESET** pushbutton to enter the diagnostic display mode. To exit the diagnostic display mode, repeat the procedure used to enter the mode.

While the monitor is in the diagnostic display mode all monitoring functions are still being performed. Any fault that occurs while in this mode will be displayed once this mode is exited. It is not possible to accidentally reset a fault while in the diagnostic display mode.

While in the diagnostic display mode, a short press of the front panel **RESET** pushbutton will advance to the next diagnostic display.

The diagnostic display sequence is:

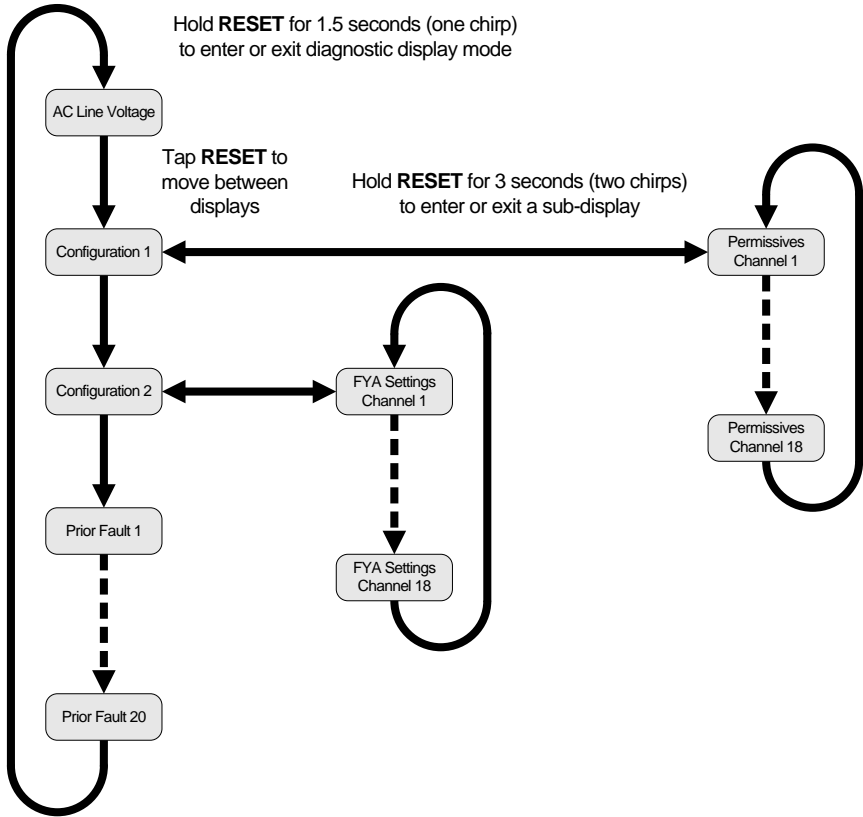

4.4.1 AC LINE VOLTAGE

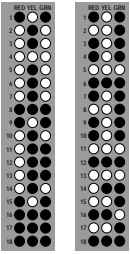

The left display is the ID Display (AC).
 The right display is the Data Display. The Data Display shows the current AC Line Voltage.
 The line voltage is updated once per second.
 In the example shown, the current AC Line Voltage is 115 VAC.

4.4.2 CONFIGURATION DISPLAY 1

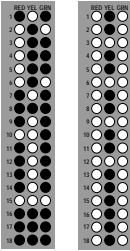

The left display is the ID Display (C1).
 The right display is the Data Display. On the Data Display:
RED - Shows the active RED FAIL switches.
YEL - Shows the active YELLOW DISABLE jumpers on the Program Card.
GRN - Shows the active DUAL ENABLE switches.
 In the example shown, Red Fail is enabled for all channels, Channels 3, 6, 9, and 12 have Yellow Disable jumpers installed, and Dual Indication is enabled for all channels.

4.4.2.1 PERMISSIVE DISPLAYS

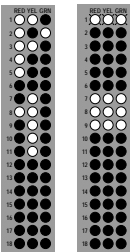

The left display is the ID Display (P1).
 The right display is the Data Display. On the Data Display:
FLASHING - The channel with the flashing **RED**, **YEL**, and **GRN** is the channel whose permissives are being displayed.
SOLID - Channels that are permissive with the flashing channel according to the diodes on the Programming Card.
 In the example shown, the Permissives for Channel 1 are being viewed and the Permissives are Channel 7, Channel 8, and Channel 9.

4.4.3 CONFIGURATION DISPLAY 2

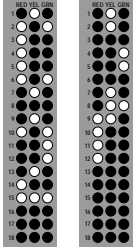

The left display is the ID Display (C2).

The right display is the Data Display. On the Data Display:

RED - Shows the active Flashing Don't Walk Monitoring channels.

YEL - Shows the active circuit board switches and jumpers.

- 1 = Flashing Don't Walk Monitoring
- 2 = Flashing Yellow Arrow Monitoring
- 3 = +24VDC Enhanced Monitoring
- 4 = Special Function 1 Invert
- 5 = Special Function 2 Invert
- 6 = Green / Yellow Monitoring
- 7 = 2010 Mode
- 8 = LED Thresholds
- 9 = Watchdog enable switch
- 10 through 12 are reserved for future features
- 13 = Do Not Allow 16 Channel Program Card
- 14 = Do Not Allow 18 Channel Program Card
- 15 = Red Enable Must Be Active
- 16 = Multi Indication & Short Yellow Always ON

GRN - Shows Software Options and Factory Setup Options.

- 1 = User Option Log Field Changes.
- 2 = Future Feature
- 3 = Special Function 2 Enable
- 4 = Flashing Yellow Arrow Ignore Yellow Conflict
- 5 = Flashing Yellow Arrow Driver is Yellow
- 6 = Force 1500ms Watchdog
- 7 = Disable Buzzer.
- 8 = Daylight Saving Time.
- 9 = Flashing Greens
- 10 = Fast Start Up
- 11 = Low AC Power Thresholds
- 12 = LA DOT Configuration
- 13 = NYS DOT Configuration
- 14 = 18 Channel Program Card Installed
- 15 = Future Feature
- 16 = Diagnostic LCD Display

In the example shown, Channels 9, 10, 11, and 12 are programmed for Flashing Don't Walk Monitoring and the feature is enabled; Flashing Yellow Arrow monitoring is enabled; 2010 mode of operation is selected; LED Thresholds are enabled; Watchdog switch is set to enabled; Flashing Yellow Arrow Ignore Yellow Conflict is enabled; Flashing Yellow Arrow Driver is Yellow is enabled; and Daylight Saving Time is enabled.

4.4.3.1 FLASHING YELLOW ARROW DISPLAYS

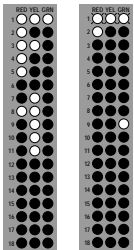

The left display is the ID Display (F1).

The right display is the Data Display. On the Data Display:

FLASHING - The channel with the flashing **RED**, **YEL**, and **GRN** is the parent channel whose Flashing Yellow Arrow childs are being displayed. If this channel has other LEDs on then, this channel should have the solid arrows for the Red, Yellow, and Green for a Flashing Yellow Arrow head connected to it.

SOLID - Channels that are programmed as either a conflicting child or a permissive child used in the Flashing Yellow Arrow display monitoring. If the **R** is on, the channel is the conflicting through channel. If the **YEL** or **GRN** is ON, the channel is where the Flashing Yellow Arrow indication is connected to the monitor and the color input that will be monitored.

In the example shown, Channel 1 is the solid arrows, Channel 2 is the conflicting through channel, and Channel 9 Green is where the Flashing Yellow Arrow indication is connected.

4.4.4 PRIOR FAULTS

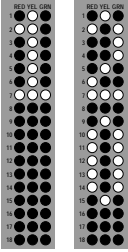

There are 20 possible Prior Faults ID Displays (1 through 20). ID Displays 1 and 20 are shown.

The Data Display for each ID Display will be the front panel status as it was when it was actually displaying the fault. All LEDs, except **AC POWER** and **COM**, are displayed in the same state as they were when the prior fault occurred.

If the display reverts back to AC Line Voltage while trying to access a particular prior fault, it means that the monitor does not have a prior fault saved for the prior fault being accessed (you have reached the end of the log).

Section 5 Firmware Upgrade

The firmware for the main microprocessor in the Model 2018E can be upgraded via the front panel COMM port. The most current version of firmware is available on the Reno A & E web site (www.renoae.com) in the support section. Firmware upgrades to the monitor are accomplished through the use of the RaeComM software, version 3.0.7 or greater.

There are three separate firmware files that can be upgraded for the main microprocessor in the monitor.

Main Code: This is the code (firmware) that runs the monitor under normal conditions. In most cases, this is the only file that must be upgraded and ends with **BOOTCODE.RAE** if more than one file is in the downloaded file.

Secondary Boot Loader: This is the code that is responsible for allowing firmware upgrades if the main code (boot code) is corrupt or becomes corrupt during the programming process and ends with **BOOTLD2.RAE**.

Primary Boot Loader: This is the code that is responsible for allowing firmware upgrades if the secondary boot loader is corrupt and ends with **BOOTLD1.RAE**. This file can only be upgraded by a user with factory level privileges.

The two boot loaders exist to allow the monitor to recover from problems during the upgrade process (power fail during programming, computer crash during programming, etc.). They should not need to be upgraded, but provisions to do so have been made in case they need to be upgraded.

To upgrade the main code:

- 1) Ensure that RaeComM version 3.1.0 or greater is installed on the computer to be used during the upgrade process.
- 2) Download the latest main code file for the monitor to be upgraded from the Reno A&E web site (www.renoae.com).
- 3) Connect the monitor to the computer through the **COMM PORT**.
- 4) Start the RaeComM program.
- 5) Ensure that the RaeComM software can communicate with the monitor to be upgraded by clicking on **IDENTIFY** in the menu and observing that the monitor is correctly identified by the program.
- 6) On the **CONFIG** menu choose **UPGRADE FIRMWARE**.
- 7) On the Code Loader form that appears, click on the file folder icon after the file name.
- 8) Select the file that was just downloaded from the Reno A&E web site. If more than one file was in the downloaded file, select the one ending with **BOOTCODE.RAE**.
- 9) If the file you selected is the correct file for the attached monitor, the Upgrade Firmware form will show the current version of firmware in the monitor and the version that is about to be transferred.
- 10) If this is correct, click on the **UPGRADE FIRMWARE** button and the process will begin. The red LED on the front panel labeled **DIAG FAIL** will begin to flash at a 5 Hz rate to indicate that the transfer process is underway.
- 11) If an error is encountered once the transfer has begun, RaeComM will automatically retry the transfer process up to five times. Do not cycle power to the monitor if an error is encountered. Attempt the transfer again by closing the Upgrade Firmware form and repeating Steps 6 through 10.
- 12) Wait a few seconds to ensure that the RaeComM software does not automatically start another upgrade process (this will happen if the boot loaders need to be upgraded and is automatic). Once the transfer is complete, the red LED on the front panel labeled **DIAG FAIL** will begin to flash at a 1 Hz rate to indicate a pending code change (i.e. new code has been downloaded but not implemented).
- 13) Cycle power to the monitor to begin running the new code. The pending code change indication will cease.

IMPORTANT Do not interrupt power to the monitor during the programming process. This will corrupt the firmware being transferred!

Each firmware file is encrypted and contains information identifying what model monitor it can be used in and what type of firmware it is. This ensures that the user cannot inadvertently upgrade a monitor with the incorrect firmware and that the firmware file has not been tampered with.