

Model 222S

Loop Detector

Operations Manual

Two-Channel DIP Switch Programmable Inductive Loop Vehicle
Detector

This manual contains technical information for the

Model 222S Loop Detector

pn 889-0753-00 Revision: April 2020



THE FOLLOWING PRODUCT WAS DESIGNED, INSPECTED, TESTED AND
MANUFACTURED IN THE USA BY EBERLE DESIGN, INC. IN PHOENIX, ARIZONA.

INFORMATION CONTAINED HEREIN IS PROPRIETARY TECHNICAL INFORMATION OF
EBERLE DESIGN, INC. PUBLICATION, REPRODUCTION OR USE IN WHOLE OR PART IS
NOT PERMITTED EXCEPT UNDER TERMS AGREED UPON IN WRITING. ALL
REGISTERED TRADEMARKS OF EBERLE DESIGN INC. ARE UNDER
© COPYRIGHT

MAINTENANCE NOTE

**IT IS AN EBERLE DESIGN, INC. RECOMMENDATION THAT EACH UNIT BE TESTED
AT LEAST ANNUALLY TO ENSURE COMPLIANCE WITH FACTORY
SPECIFICATIONS AND MEETS PROPER OPERATIONAL STANDARDS. THE
RESULTS OF THIS TESTING WILL BE DOCUMENTED.**

Model 222S Operations Manual

Table of Contents

Section 1 General Description	1
Section 2 General Characteristics	2
2.1 Loop Frequency (Front Panel Mounted DIP Switches).....	2
2.2 Sensitivity (Front Panel Mounted DIP Switches).....	2
2.3 Presence/Pulse (Front Panel Mounted DIP Switch).....	2
2.4 Fail-Safe / Fail-Secure (Front Panel Mounted DIP Switch).....	2
2.5 Disable Channel (Front Panel Mounted DIP Switch).....	2
2.6 100ms Minimum Output (PC Board Mounted DIP Switch).....	2
2.7 Audible Detect Signal (PC Board Mounted DIP Switch).....	3
2.8 Call / Test (Front Panel Mounted Toggle Switch).....	3
Section 3 Specifications	4
3.1 Physical.....	4
3.2 Electrical.....	4
3.3 Operational.....	4
3.4 Table: Sensitivity, $-\Delta L/L$, and Response Times.....	5
3.5 Table: Default Settings (Front Panel Mounted DIP Switches).....	5
3.6 Table: Default Settings (PCB Mounted DIP Switches).....	5
3.7 Tables: Pin Assignments.....	6
Section 4 User Interface	7
Section 5 Installation and Set-Up	8
5.1 Front Panel Programming DIP Switches.....	8
5.2 Front Panel Test Toggle Switches.....	9
5.3 PC Board Mounted Programming DIP Switches.....	9
5.4 Loop Fail Indications.....	10
5.5 Resetting the Detector.....	10
Section 6 Block Diagram	11
Section 7 Theory of Operation	12
Section 8 Maintenance and Troubleshooting	14
8.1 Troubleshooting Power Problems.....	14
8.2 Troubleshooting Loop Fail Problems.....	15
8.3 Troubleshooting Intermittent Loop Fail Problems.....	16
8.4 Troubleshooting Intermittent Detector Lock Ups.....	16
8.5 Test Mode Operation.....	16
8.6 Voltage and Waveform Measurements.....	19
8.7 Things to Know About Loops.....	20
Section 9 Schematic	21
Section 10 PCB Layout	22
Section 11 Parts List	24

Section 1 General Description

This Product Manual was written for people installing, operating, and troubleshooting Reno A&E Model G 222S inductive loop vehicle detectors. The Model 222S is a scanning, two channel, card rack type loop detector designed for use in installations requiring a Type 332 (170 controller) detector. The Model 222S incorporates a three-position Call / Test switch for each channel that can be used to simulate a continuous or momentary CALL output.

The Model 222S uses a microcontroller to monitor and process signals from two separate loop/lead-in circuits. The operation of each channel is independently programmed with a front panel eight-position DIP switch to provide the following selections:

- Eight Sensitivity Levels %(- Δ L/L)
- Presence or Pulse Mode
- Fail-Safe or Fail-Secure operation in a loop fail condition
- Four Frequency Selections
- Channel Disable

The FAIL-SAFE / FAIL-SECURE switch selects the channel output state as “CALL” or “NO CALL” during a loop failure condition. The FAIL-SAFE selection, which is the standard for intersection control, generates a continuous “CALL” output state for as long as a loop failure condition exists. The FAIL-SECURE selection generates a “NO CALL” output state during a loop failure condition. Traffic control applications such as incident detection prefer the Fail-Secure operation, because a constant “CALL” from a failed loop appears as though the traffic movement has stopped. The FAIL-SECURE selection also selects faster response times for very accurate speed measurement. The switch selection allows the user to set the detector operation for the application.

The Model 222S detector is a scanning detector. The scanning operation sequentially activates the ON and OFF cycle of each channel’s oscillator. Because only one channel’s loop(s) is active at a given time, crosstalk between adjacent loops connected to the same scanning detector is minimized. The Model 222S Series’ unique scanning process also disconnects the capacitors and dampens the oscillator during the off cycle. This eliminates oscillation past the OFF point (ringing or decay) every time the loop circuit is scanned which can result in crosstalk. The four frequency settings can be selected to provide different frequency settings when changing frequency settings to minimize crosstalk. NOTE: Adjacent loops connected to different channels of a non-scanning detector or different scanning detectors should be set to different frequencies with maximum separation. Each time the loop circuit is activated, loop data is obtained and recorded. The data is compared to previous samples for the amount and rate of change. A slow rate of change, as is the case with environmental drift, is continuously tracked. If a rapid change exceeds a threshold set by the sensitivity level, the output is activated.

If the total inductance of the loop input network goes out of the range specified for the detector, or rapidly changes by more than $\pm 25\%$, the channel will enter the programmed FAIL-SAFE or FAIL-SECURE mode of operation. The DETECT / FAIL LED will begin to display an indication of the particular failure condition and will continue to do so as long as the loop fault exists. If the loop “self heals”, the channel will resume operation in a normal manner; except the DETECT / FAIL LED will begin a burst of 3 red flashes each second, thus providing an alert that a Loop Fail condition has occurred. The DETECT / FAIL LED will continue flashing indicating the prior loop failure condition until the detector is manually reset or power is removed.

In addition, the Reno A&E Model 222S has a Test Mode that thoroughly tests the detector module without the need for external test equipment. The Test Mode uses the microcontroller to verify the proper operation of the entire detector’s input and output circuitry including switches, LEDs and outputs. Each channel’s loop oscillator circuit can also be tested to verify the correct frequency range in each of the 4 frequency selections.

The Model 222S Series is comprised of the following detectors:

Model 222S-R	For applications needing a two channel, 332 (170 Controller) rack mount detector with relay outputs
Model 222SB-R	For applications needing a two channel, 332 (170 Controller) rack mount detector with relay outputs and an audible detect buzzer
Model 222S-SS	For applications needing a two channel, 332 (170 Controller) rack mount detector with solid state outputs
Model 222SB-SS	For applications needing a two channel, 332 (170 Controller) rack mount detector with solid state outputs and an audible detect buzzer.

Section 2 General Characteristics

2.1 LOOP FREQUENCY (FRONT PANEL MOUNTED DIP SWITCHES)

There are four (4) selectable loop frequency settings (normally in the range of 20 to 100 kiloHertz) for each channel. The actual loop operating frequency is a function of the loop/lead-in network and the components of the loop oscillator circuit. Adjacent loops connected to different detectors may crosstalk and require changing of the operating frequency of one of the loop circuits. If crosstalk is a problem, select another loop frequency for stable operation. The four frequency selections for each channel are controlled with two switches marked 2 and 3 on the front panel mounted DIP switch.

NOTE: The detector must be reset after changing the frequency setting.

2.2 SENSITIVITY (FRONT PANEL MOUNTED DIP SWITCHES)

There are eight (8) selectable sensitivity levels for each channel. The sensitivity levels are designed so that a one level increase actually doubles the sensitivity and a one level decrease halves the sensitivity. The eight sensitivity levels are selected with three switches marked 6, 7, and 8 on each front panel mounted DIP switch.

NOTE: Changing the sensitivity level setting will reset the detector.

Level	0	1	2	3	4	5	6	7
-ΔL/L	1.28%	0.64%	0.32%	0.16%	0.08%	0.04%	0.02%	0.01%

2.3 PRESENCE/PULSE (FRONT PANEL MOUNTED DIP SWITCH)

Two modes of operation for each channel of the detector are available. Presence or Pulse mode is selected by setting the state of either channel's front panel DIP switch 5.

PRESENCE MODE: Provides a Call hold time of at least 4 minutes (regardless of vehicle size) and typically 1 to 3 hours for an automobile or truck. This is the factory default setting and the most common setting.

PULSE MODE: An output Pulse of 125 ± 10 milliseconds duration is generated for each vehicle entering the loop detection zone. Each detected vehicle is instantly tuned out if it remains in the loop detection zone longer than 2 seconds. This enables detection of subsequent vehicles entering the loop detection zone. After each vehicle leaves the loop detection zone, the channel resumes full sensitivity within 1 second.

NOTE: Changing the MODE switch will RESET the channel.

2.4 FAIL-SAFE / FAIL-SECURE (FRONT PANEL MOUNTED DIP SWITCH)

The Fail-Safe or Fail-Secure mode of operation is selectable for each channel by means of the two front panel mounted DIP switches marked 4.

During a loop failure condition, the state of the channel's output can be selected as "CALL" in the Fail-Safe mode of operation or "NO CALL" in the Fail-Secure mode of operation. Fail-Safe operation during a loop failure is the standard operation for intersection control. Fail-Secure operation during a loop failure is typically used for incident detection systems for freeway management. The Fail-Secure selection also selects fast response for very accurate speed and occupancy measurements (see Response Times).

NOTE: Changing this setting will RESET the channel.

2.5 DISABLE CHANNEL (FRONT PANEL MOUNTED DIP SWITCH)

Each detector channel can be disabled by setting its front panel DIP switch 1 to the ON position. When set to the ON position, the channel output is continuously in the "NO-CALL" state regardless of the presence or absence of vehicles over the loop. The loop oscillator is not activated when the channel is in the "Disabled" state.

NOTE: Changing this setting will RESET the channel.

2.6 100MS MINIMUM OUTPUT (PC BOARD MOUNTED DIP SWITCH)

Two modes of operation are available for the CALL outputs of the detector when operating in the presence mode. Normal mode and 100ms Minimum Output mode are selected by setting DIP switch 2 on the four position DIP switch located near the upper right corner of the PC Board. When DIP switch 2 is in the OFF position, the CALL outputs stay on only as long as the detection zone is occupied. When DIP switch 2 is in the ON position, every CALL output will have a minimum duration of 100ms. This feature is used to insure that CALLs output by the

detector will be seen by the controller. Some controllers do not check the detector outputs often enough to catch very short detection events (<100ms). This feature will cause all detection events less than 100ms long to be 100ms long.

2.7 AUDIBLE DETECT SIGNAL (PC BOARD MOUNTED DIP SWITCH)

DIP switch 3 on the four-position DIP switch located near the upper right corner of the PC Board is used to enable an Audible Detect Signal. When this option is enabled (on), an audible signal will be activated whenever the detection zone for the selected channel is occupied. The audible signal indicates actual occupancy of the loop detection zone. Only one channel can be turned on at a time. Turning this option on for one channel automatically turns it off for the other channels. To activate this feature, DIP switch 3 must be set to the ON position. Then any change made to the Sensitivity Level (front panel DIP switches 6, 7, and 8) or Presence / Pulse setting (front panel DIP switch 5) of the desired channel will activate this feature for that channel. This feature allows a technician to watch the detection zone on the street and confirm correct detector operation without having to look at the detector display as well. This option is automatically disabled 15 minutes after activation or on loss of power.

NOTE: This feature is available on the Model 222SB-R and 222SB-SS only.

2.8 CALL / TEST (FRONT PANEL MOUNTED TOGGLE SWITCH)

Each detector channel can be independently set to provide a simulated CALL output. Each channel has a front panel mounted, three-position toggle switch that can be used to short the detector channel's output terminals in either a continuous (CALL) or momentary (TEST) closed state. When set to the center (NORM) position, the channel(s) operate normally. This feature is useful when troubleshooting problems related to detector outputs and / or controller inputs.

NOTE: When operating in TEST mode, the simulated CALL output is maintained as long as the toggle switch is held in the TEST position.

Section 3 Specifications

3.1 PHYSICAL

WEIGHT: 6 oz. (170 gm.).

SIZE: 4.50 inches (11.43 cm.) high x 1.12 inches (2.84 cm.) wide x 6.875 inches (17.46 cm.) long including connector.

OPERATING TEMPERATURE: -40°F to +180°F (-40°C to +82°C).

CIRCUIT BOARD: Printed circuit boards are 0.062 in. thick FR4 material with 2 oz. copper on both sides and plated through holes. Circuit board and components are conformal coated with polyurethane.

CONNECTORS: 2 x 22 pin edge card connector with 0.156 inch (0.396 cm.) contact centers. Key slots located between B/2 & C/3, E/5 & F/6, and M/11 & N/12. See section 3.6 for pin assignments.

3.2 ELECTRICAL

POWER: 10.8 to 30 VDC. Solid State output version - 100mA max. Relay version - 130mA max.

LOOP INDUCTANCE RANGE: 20 to 2500 microhenries with a Q factor of 5 or greater.

LOOP INPUTS: Transformer isolated. The minimum capacitance added is 0.068 microfarad.

LIGHTNING PROTECTION: Each channel can tolerate, without damage, a 10 microfarad capacitor charged to 2,000 volts being discharged directly into the loop input terminals, or a 10 microfarad capacitor charged to 2,000 volts being discharged between either loop terminal and earth ground.

RESET: Each detector channel can be manually reset by momentarily changing any switch position (except the frequency switches). The detector is also reset by connecting a logic ground signal to pin C of the card edge connector or the return of power after a power loss.

RELAY RATING: The relay contacts are rated for 6 Amps max., 150 VDC max., and 180 Watts max. switched power.

SOLID STATE OUTPUT RATING (optional): Optically coupled transistors. 30 VDC max. collector to emitter. 50 mA max. saturation current. 1.2 VDC max. transistor saturation voltage. The output is protected with a 33-volt Zener diode connected between the collector and emitter.

3.3 OPERATIONAL

DETECT / FAIL INDICATORS: The detector has one super bright, high intensity, two color (green / red) light emitting diode (LED) per channel to indicate a CALL output and/or the status of any current or prior loop failure conditions. A continuous On (green) state indicates a CALL output. A continuous On (red) state indicates that a current open loop failure condition or an inductance change condition of greater than +25% exists. When operating in Fail-Safe mode, this indication also generates a CALL output. When operating in Fail-Secure mode, no CALL output is generated. A one Hz (red) flash rate indicates that a current shorted loop failure condition or an inductance change condition of greater than -25% exists. When operating in Fail-Safe mode, this indication also generates a CALL output. When operating in Fail-Secure mode, no CALL output is generated. A flash rate of three 50 millisecond (red) pulses indicates a prior loop failure condition. A flash rate of three 50 millisecond (red) pulses followed by a single 750 millisecond (green) pulse indicates a prior loop failure condition and a current CALL output (detect state).

Detect / Fail LED	Meaning
Off	No Detect (No CALL Output)
Solid ON (Green)	Detect (CALL Output)
Solid ON (Red)	Open Loop Failure Or Inductance change condition of greater than +25% exists
1 Hz flash rate (Red) (50% Duty Cycle)	Shorted Loop Failure Or Inductance change condition of greater than -25% exists
Burst of three 50 ms (Red) flashes every 1 second	Loop Failure condition occurred but no longer exists
Burst of three 50 ms (Red) flashes every 1 second followed by a single 750 ms (Green) flash	Loop Failure condition occurred but no longer exists And Detect (CALL Output)

RESPONSE TIME: Meets or exceeds NEMA TS 2 and Caltrans response time specifications. (See Table, "Sensitivity, -ΔL/L, & Response Times" for actual response times).

SELF-TUNING: The detector automatically tunes and is operational within 2 seconds after application of power or after being reset. Full sensitivity and hold time require 30 seconds of operation.

ENVIRONMENTAL & TRACKING: The detector is fully self-compensating for environmental changes and loop drift over the full temperature range and the entire loop inductance range.

GROUNDING LOOP OPERATION: The loop isolation transformer allows operation with poor quality loops (which may include one short to ground at a single point).

LOOP FEEDER LENGTH: Up to 5000 feet (1500 m.) maximum with proper feeder cable and appropriate loops.

LOOP (FAIL) MONITOR: If the total inductance of the channel's loop input network goes out of the range specified for the detector, or rapidly changes by more than $\pm 25\%$, the channel will immediately enter the programmed Fail-Safe mode of operation. The Fail-Safe mode of operation generates a continuous call during the loop failure. The DETECT / FAIL LED will provide an indication to identify the type of loop failure condition which exists. A continuous On (red) state indicates that a current open loop failure condition or an inductance change condition of greater than $+25\%$ exists. A one Hz (red) flash rate indicates that a current shorted loop failure condition or an inductance change condition of greater than -25% exists. If the loop "self heals", the channel will resume operation in a normal manner except that the DETECT / FAIL LED will begin a burst of three 50 millisecond (red) flashes per second, thus providing an alert that the channel has experienced a prior loop failure condition. During this state, the DETECT / FAIL LED will also illuminate for 750 milliseconds (green) for a CALL output. The FAIL LED will continue flashing in this sequence indicating the prior loop failure condition and/or detect state until the detector is manually reset or power is removed.

3.4 TABLE: SENSITIVITY, - Δ L/L, AND RESPONSE TIMES

Sensitivity Level	Industry Reference	DIP Switch 6	DIP Switch 7	DIP Switch 8	- Δ L/L Threshold	Response Time (Fail-Secure Mode)	Response Time (Fail-Safe Mode)
0		OFF	OFF	OFF	1.28%	3.5 \pm 2.5 ms	65 \pm 25 ms
1		ON	OFF	OFF	0.64%	3.5 \pm 2.5 ms	65 \pm 25 ms
2	Low	OFF	ON	OFF	0.32%	3.5 \pm 2.5 ms	65 \pm 25 ms
3		ON	ON	OFF	0.16%	3.5 \pm 2.5 ms	65 \pm 25 ms
4	Normal	OFF	OFF	ON	0.08%	4.5 \pm 3.5 ms	65 \pm 25 ms
5		ON	OFF	ON	0.04%	7 \pm 6 ms	65 \pm 25 ms
6	High	OFF	ON	ON	0.02%	11.5 \pm 10.5 ms	65 \pm 25 ms
7		ON	ON	ON	0.01%	21.5 \pm 20.5 ms	65 \pm 25 ms

Note: To achieve the response times listed above, the Sensitivity and Fail-Safe/Fail-Secure settings for both channels must be set the same.

3.5 TABLE: DEFAULT SETTINGS (FRONT PANEL MOUNTED DIP SWITCHES)

DIP Switch	Function	Setting	Position
1	Disable	OFF	OFF
2	Frequency	0 (High)	OFF
3			OFF
4	Fail-Safe / Fail-Secure	Fail-Safe	ON
5	Presence / Pulse Mode	Presence	ON
6	Sensitivity	4	OFF
7			OFF
8			ON

3.6 TABLE: DEFAULT SETTINGS (PCB MOUNTED DIP SWITCHES)

DIP Switch	Function	Setting	Position
1	Test Mode	Test Mode Off	OFF
2	100 ms Minimum Output	100 ms Minimum Output Off	OFF
3	Audible Detect Signal (Buzzer)	Audible Detect Signal Off	ON
4	(Reserved for future use)	N/A	OFF

3.7 TABLES: PIN ASSIGNMENTS

MODEL 222S (SOLID STATE OUTPUTS)

Pin	Function
A	D.C. (-) Common
B	D.C. (+) Power
C	Reset Input
D/4	Ch. 1 Loop Input
E/5	Ch. 1 Loop Input
F	Ch. 1 Output, Drain
H	Ch. 1 Output, Source
J/8	Ch. 2 Loop Input
K/9	Ch. 2 Loop Input
L	Chassis Ground
M	No Connection
N	No Connection
P	No Connection
R	No Connection
S	No Connection
T	No Connection
U	No Connection
V	No Connection
W	Ch. 2 Output, Drain
X	Ch. 2 Output, Source
Y	No Connection
Z	No Connection

MODEL 222S (RELAY OUTPUTS)

Pin	Function
A	D.C. (-) Common
B	D.C. (+) Power
C	Reset Input
D/4	Ch. 1 Loop Input
E/5	Ch. 1 Loop Input
F	Ch. 1 Output, Normally Open
H	Ch. 1 Output, Common
J/8	Ch. 2 Loop Input
K/9	Ch. 2 Loop Input
L	Chassis Ground
M	No Connection
N	No Connection
P	No Connection
R	No Connection
S	No Connection
T	No Connection
U	No Connection
V	No Connection
W	Ch. 2 Output, Normally Open
X	Ch. 2 Output, Common
Y	No Connection
Z	No Connection

Section 4 User Interface

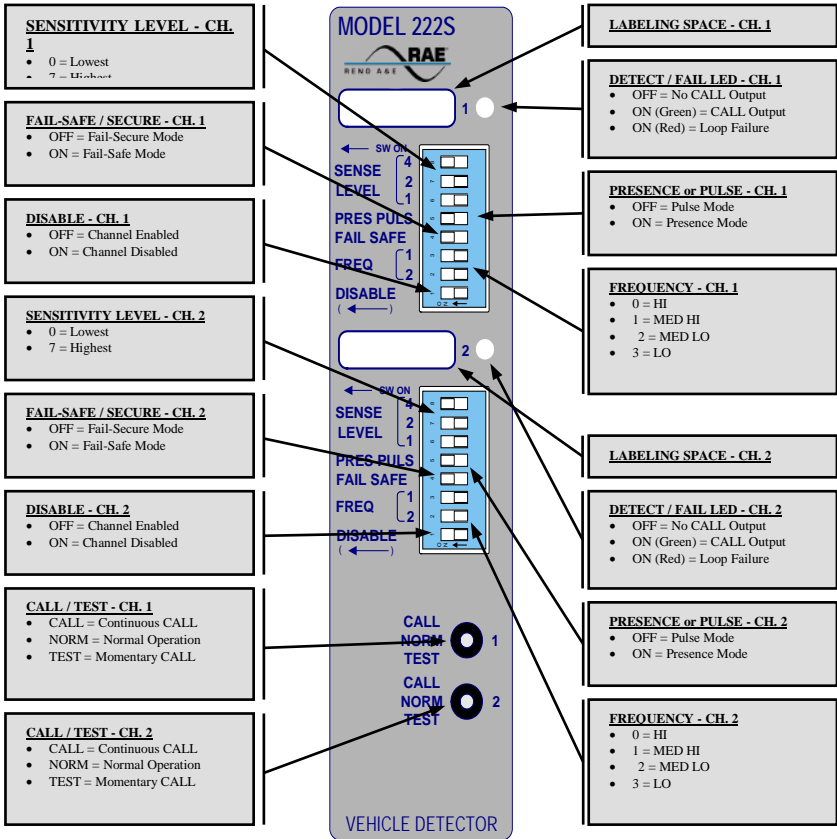

NOTE: There is a four-position DIP switch located near the upper right corner of the PC Board. DIP switch 1 must be in the OFF position for the detector to function properly.

Section 5 Installation and Set-Up

Each channel has a front panel mounted eight-position DIP switch to control the operation of the channel. There is also a four-position DIP switch located near the upper right corner of the PC Board. The various switches can be set before or after the detector card is inserted into the card rack. The PRESENCE / PULSE, FAIL-SAFE, and DISABLE switches on the eight-position DIP switch and the 100 MILLISECOND MINIMUM OUTPUT switches on the four-position DIP switches can be pre-selected for the desired modes operation. The SENS LEVEL and FREQ switches may require adjustment after the detector card has been inserted. When the detector is inserted, each channel will automatically tune to the loop circuit and begin operation within two seconds.

Ensure that DIP switch 1 labeled TEST on the four-position DIP switch located near the upper right corner of the PC Board is set to the OFF position. This switch must be OFF for the detector to operate correctly. Set both CALL / TEST toggle switches to their NORM position. Plug the detector into an appropriately wired harness or card rack and apply power.

5.1 FRONT PANEL PROGRAMMING DIP SWITCHES

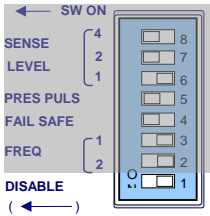

Disable: Under certain circumstances, it may be desirable to turn off or disable one or both detector channel(s). This can be accomplished by moving front panel DIP switch 1, labeled DISABLE, to its ON position. When a channel is disabled, the channel output is continuously in the “NO-CALL” state regardless of the presence or absence of vehicles over the loop. The loop oscillator is not activated when the channel is in the “Disabled” state.

NOTE: Changing this setting will RESET the channel.

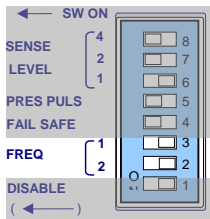

Frequency: The Model 222S detector sequentially activates each channel’s loop circuit; therefore crosstalk between adjacent loops connected to different channels of the same detector is normally not a concern. However, adjacent loops connected to different detectors may crosstalk and require changing the operating frequency of one of the loop circuits. If crosstalk is a problem, select another loop frequency for stable operation. Each channel of the Model 222S has four frequency selections that allow altering the resonant frequency of the loop circuit. The four frequency selections are controlled with two switches marked 2 and 3 on the front panel mounted DIP switch. The values (1,2) to the left of the DIP switch are assigned to the switch when the switch is ON. If the switch is OFF, the switch has a value of zero (0). By adding the switch “ON” values, the two switches will combine for values from 0 to 3 that indicate the four Frequency selections. The following table is a reference for the selections.

NOTE: After changing the frequency switch setting(s), it is necessary to reset the detector channel by momentarily changing one of the other switch positions.

Frequency	Switch 3	Switch 2	Switch Value
HI *	OFF *	OFF *	0 + 0 = 0 *
MED HI	ON	OFF	1 + 0 = 1
MED LO	OFF	ON	0 + 2 = 2
LO	ON	ON	1 + 2 = 3

* Factory default setting.

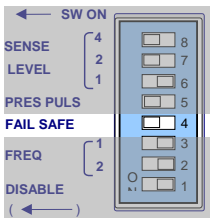

Fail-Safe / Fail-Secure: Fail-Safe or Fail-Secure mode of operation for either channel is selectable using the front panel DIP switches labeled FAIL SAFE (DIP switch 4). When the DIP switch corresponding to a given channel is in the ON position, that channel will operate in the Fail-Safe mode.

During a loop failure condition, the state of the channel’s output can be selected as “CALL” in the Fail-Safe mode of operation or “NO CALL” in the Fail-Secure mode of operation. Fail-Safe operation during a loop failure is the standard operation for intersection control. Fail-Secure operation during a loop failure is typically used for incident detection systems for freeway management. The factory default setting of this feature is ON (Fail-Safe Mode) for both channels.

NOTE: Changing this setting will RESET the channel.

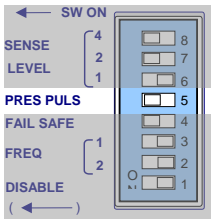

Presense / Pulse Output Mode: One of two output modes can be selected for each channel by means of the two front panel mounted DIP switches marked 5, labeled PRES PULS.

PRESENCE (PRES): When the switch is in the ON position, Presence Mode is selected. Presence Mode will hold the smallest vehicle for four minutes minimum and either a small truck or a car typically for one to three hours. This is the factory default setting and the most common setting.

PULSE (PULS): When the switch is in the OFF position, Pulse Mode is selected. Pulse Mode will generate a single 125 millisecond pulse output for each vehicle entering the loop detection area. Any vehicle remaining in the loop longer than two seconds will be “tuned out” providing full sensitivity for the vacant portion of the loop detection zone. Full sensitivity for the entire loop detection zone is recovered within one second following the departure of any vehicle, which has occupied the loop for longer than two seconds.

NOTE: Changing this setting will RESET the channel.

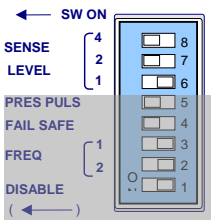

Sensitivity Level: Each detector channel has eight sensitivity levels that are selected with three switches marked 6, 7, and 8 on the front panel mounted DIP switch. The values (1, 2, and 4) to the left of the DIP switch are assigned to each switch when the switch is ON. If the switch is OFF, the switch has a value of zero (0). By adding the switch “ON” values, the three switches will combine for values from 0 to 7 indicating which of the eight sensitivity levels has been selected for the channel. Choose the lowest sensitivity level that will consistently detect the smallest vehicle desired. Do not use any sensitivity level higher than necessary. The factory default position is sensitivity level 4 (-ΔL/L = 0.08%). The following table shows the actual sensitivity for each combination of switch positions.

NOTE: Changing any switch setting(s) will RESET the channel.

Sensitivity Level	Industry Reference	DIP Switch 6	DIP Switch 7	DIP Switch 8	Switch Values	-ΔL/L Threshold
0		OFF	OFF	OFF	0 + 0 + 0 = 0	1.28%
1		ON	OFF	OFF	1 + 0 + 0 = 1	0.64%
2	Low	OFF	ON	OFF	0 + 2 + 0 = 2	0.32%
3		ON	ON	OFF	1 + 2 + 0 = 3	0.16%
4*	Normal	OFF	OFF	ON	0 + 0 + 4 = 4	0.08%
5		ON	OFF	ON	1 + 0 + 4 = 5	0.04%
6	High	OFF	ON	ON	0 + 2 + 4 = 6	0.02%
7		ON	ON	ON	1 + 2 + 4 = 7	0.01%

* Factory default setting.

5.2 FRONT PANEL TEST TOGGLE SWITCHES

The Model 222S detector has two front panel mounted three-position toggle switches labeled 1 and 2 that can be used to simulate a CALL output. Each detector channel can be independently set to provide a simulated CALL output. When the toggle switch for a given channel is in its center (NORM) position, the detector channel operates in a normal manner. The detector channel responds to vehicle presence in the loop detection area and outputs a CALL signal whenever a vehicle is detected. The toggle switches can be used to short the detector channel’s output terminals in either a continuous (CALL) or momentary (TEST) closed state, and thereby provide a simulated CALL output. This feature is useful when troubleshooting problems related to detector outputs and / or controller inputs.

NOTE: When operating in TEST mode, the simulated CALL output is maintained as long as the toggle switch is held in the TEST position.

5.3 PC BOARD MOUNTED PROGRAMMING DIP SWITCHES

Test: The Test Mode uses the microcontroller to verify the proper operation of the entire detector’s input and output circuitry including switches, LEDs and outputs. Each channel’s loop oscillator circuit is also checked to verify the correct frequency in each of the four frequency selections. Test mode is selected by means of DIP switch 1 on the four-position DIP switch located near the upper right corner of the PC Board. Refer to Section 8.5 for a complete explanation of Test Mode operation. The factory default setting of this switch is off (Test mode OFF).

100 Millisecond Minimum Output: Two modes of operation are available for the CALL outputs of the detector when operating in the presence mode. Normal mode or 100ms Minimum Output mode are selected by means of DIP switch 2 on the four-position DIP switch located near the upper right corner of the PC Board. When this switch is in the OFF position, the CALL outputs stay on only as long as the detection zone is occupied. When this switch is in the ON position, every CALL output will have a minimum duration of 100ms. This feature is used to insure that CALLs output by the detector will be seen by the controller. Some controllers do not check the detector outputs often enough to catch very short detection events (<100ms). This feature has the effect of forcing all detection events less than 100ms long to be 100ms long. The factory default setting of this feature is OFF (100 Millisecond Minimum Output Off).

Audible Detect Signal (Buzzer): DIP switch 3 on the four-position DIP switch located near the upper right corner of the PC Board is used to enable an audible detect signal which is emitted any time that a given channel's detection zone is occupied. To activate this feature, DIP switch 3 must be set to the ON position. Then any change made to the Sensitivity Level (front panel DIP switches 6, 7, and 8) or Presence / Pulse setting (front panel DIP switch 5) of the desired channel will activate this feature for that channel. Only one channel can have this feature active at any given time. Therefore, the last channel to have a DIP switch changed will be the active channel. This feature will automatically turn off 15 minutes after activation. The factory default setting of this feature is ON (Audible Detect Signal On).

NOTE: This feature is available on the Models 222SB-R and 222SB-SS only.

5.4 LOOP FAIL INDICATIONS

The DETECT / FAIL LED for each channel indicates loop failure problems according to the following table. The DETECT / FAIL LED is illuminated in a green state to indicate the presence of vehicles in the loop detection area. The DETECT / FAIL LED is illuminated in a red state to provide an indication of either a current or prior out of tolerance (loop failure) condition. A continuous On (red) state indicates that a current open loop failure condition or an inductance change condition of greater than +25% exists. A one Hz (red) flash rate indicates that a current shorted loop failure condition or an inductance change condition of greater than -25% exists. If the loop "self heals", the channel will resume operation in a normal manner except that the DETECT / FAIL LED will begin to display a burst of three 50 millisecond (red) flashes per second, thus providing an alert that the channel has experienced a prior loop failure condition.

Detect / Fail LED	Meaning
OFF	No Loop Failure
Solid ON (Red)	Open Loop Failure Or Inductance change condition of greater than +25% exists
1 Hz flash rate (Red) (50% Duty Cycle)	Shorted Loop Failure Or Inductance change condition of greater than -25% exists
Burst of three 50 ms (Red) flashes every 1 second	Loop Failure condition occurred but no longer exists

5.5 RESETTING THE DETECTOR

Changing the position of any of an individual channel's front panel mounted DIP switches (except the Frequency switches) resets the channel. When the detector is installed and operating, the most convenient method for resetting is to momentarily change the position of the PRES/PULS DIP switch and then return it to its original position.

Changing the position of DIP switch 1 on the four-position DIP switch located near the upper right corner of the PC Board resets the detector. The detector can also be reset by connecting a logic ground signal to Pin C of the edge card connector or by the reapplication of power after a power loss.

Section 6 Block Diagram

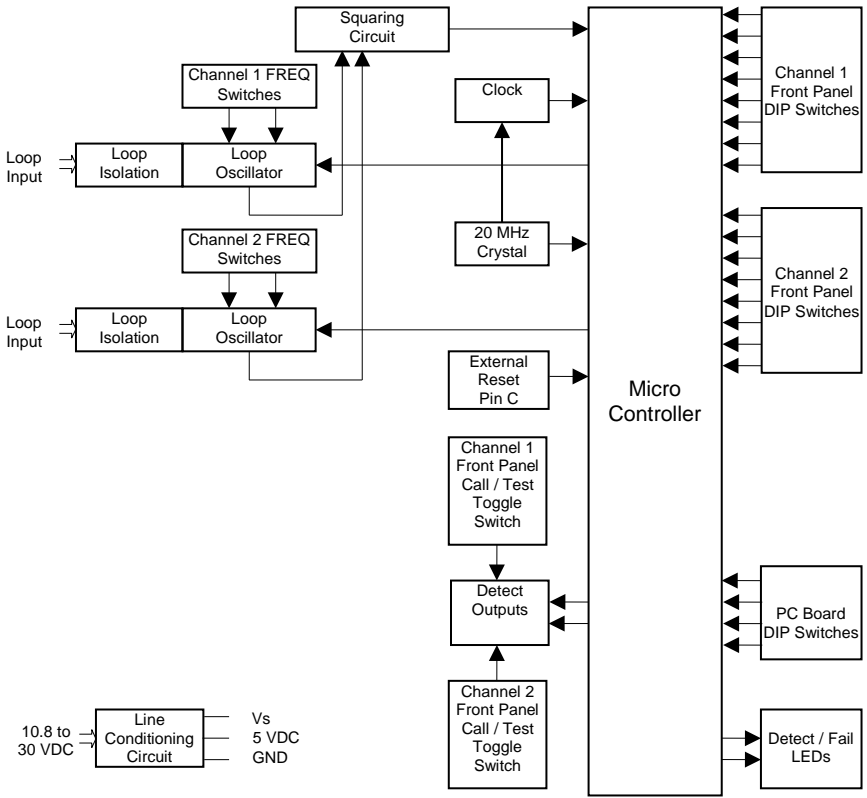

Section 7 Theory of Operation

The Reno A & E Model 222S Detector digitally measures changes in the resonant frequency of two independent parallel tuned resonant circuits (loop/lead-in) to determine if a vehicle has entered the detection zones. The detector applies an excitation voltage to each loop circuit resulting in each loop oscillating at its resonant frequency. The current flow in the loop wire creates magnetic fields around the loop wire. When a vehicle passes over the loop area, the conductive metal of the vehicle causes a loading of the loop's magnetic fields. The loading decreases the loop inductance, which causes the resonant frequency to increase. By continuously sampling the loop's resonant frequency, the magnitude and rate of change can be determined. If the frequency change exceeds a selectable threshold (set by the sensitivity settings), the detector will activate an output signal. If the rate of change is slow, typical of environmental drift, the detector will continuously track and compensate for the change. The detector also monitors the loop frequency for "out of range conditions" such as an opened or shorted loop circuit.

The detector scans the loop/lead-in circuits connected to each detector channel. The scanning method alternates the on and off cycle of each channel's loop circuit such that only one channel's loop circuit is active at a given time. Each channel's oscillator circuit supplies the excitation voltage that is coupled to the loop circuit by a loop isolation transformer. The transformer provides high common mode isolation between the loop and detector electronics, which allows the detector to operate on poor quality loops including a single short to ground. The transformer also limits the amount of static energy (lightning) that can transfer to the detector electronics. A spark gap transient suppression device is connected across the loop inputs to the isolation transformer. This device will dissipate static charges prior to the transformer. The loop input is also filtered for 60-cycle noise. A network of three capacitors is connected to the detector side of the isolation transformer. The capacitors can be switched in or out of the oscillator circuit to shift the frequency of the loop circuit thus providing frequency separation between adjacent loops.

The sine wave from the loop circuit is squared for the microcontroller to digitally measure the period of several cycles. A high-speed clock sets a reference count for the period in a counter. If the frequency increases, the period is shorter and the period count decreases. By comparing the new count with the reference count, a percentage of change can be calculated that indirectly relates to the inductance change. If the magnitude of the change exceeds a selectable threshold (sensitivity setting), the detector activates the output device.

The rate of change is also monitored. Slow rates of change, typical of environmental drift, are tracked and automatically compensated. If the total inductance of the loop input network goes out of the range specified for the detector, or rapidly changes by more than $\pm 25\%$, the channel will immediately enter the programmed Fail-Safe or Fail-Secure mode of operation. Fail-Safe operation generates a continuous call output in the Presence or Pulse Mode. Fail-Secure operation does not generate a call output during the loop failure. In both methods of operation the DETECT/FAIL LED will turn ON (red) or flash (red) at a one Hertz rate and remain on or continue flashing for as long as the loop failure exists. If the loop "self heals", the channel will resume operation in a normal manner; except the DETECT/FAIL LED will begin to display a pattern of three red flashes every one second, thus providing an alert of a prior Loop Fail condition. The DETECT/FAIL LED will continue indicating the last loop failure condition until the detector is manually reset or power is removed.

The detector is designed to operate from D.C. power sources providing either 12 VDC or 24 VDC. On board regulators provide regulated voltages so that the detector can safely operate over the full input voltage range of 10.8 VDC to 30 VDC. The unit is also provided with an external reset capability. When Pin C receives a logic ground signal for a minimum of 16 milliseconds, all detector channels are immediately reset. Changing any front panel switch (except the frequency switches) resets the associated channel.

The operating parameters of each detector channel are established by switch settings on two front panel mounted DIP switches and a PC Board mounted DIP switch. Operating parameters that can be selected by means of the front panel DIP switches are: Channel disable, loop frequency, Fail-Safe/Fail-Secure operation, presence/pulse mode, and sensitivity. Operating parameters that can be selected via the PC Board mounted DIP switch are: test mode, 100 millisecond minimum output, and audible detect signal activation. The loop frequency switches are directly connected to the tuning capacitors in the loop oscillator circuits. The settings of the remaining switches are strobed into the microprocessor. The microprocessor provides a separate output line for each channel. Each output line drives a "Fail-Safe" optically isolated transistor. Solid state output devices provide faster turn ON and turn OFF times thus giving more accurate information when the detector is used in speed and/or occupancy applications. Other output signals are connected to two, dual color (green/red), front panel mounted detect/fail LEDs. Each LED corresponds to an individual detector channel. The detect/fail LEDs are normally extinguished when there are no detect outputs, the loops are in tolerance, and there have been no previous failure conditions. A detect/fail LED will be steady ON (green) when a current detect output state exists. A detect/fail LED will be steady ON (red) when a current open loop failure or an inductance change condition of more than 25% exists. A detect/fail LED will flash at a one Hz rate (red) when a current shorted loop failure or an inductance change condition of less than 25% exists. When a detect/fail LED flashes at a rate of three 50 millisecond flashes per second (red), it is an indication that the loop is currently in tolerance, but the detector channel has previously experienced an out of tolerance condition. If a current detect output state exists and a detector channel has previously experienced an out of tolerance condition, the corresponding detect/fail LED will flash at a rate of three 50 millisecond flashes per second (red) followed by a single 750 millisecond flash (green). Either of these prior failure detect/fail LED flashing conditions will be reset whenever an external reset occurs on Pin C, the channel is reset, or power is interrupted.

The detector offers a choice of operation in either Fail-Safe or Fail-Secure mode. Fail-Safe operation is the proper choice for intersection control applications where the detector should output a “vehicle detect” condition in the event of either a loop failure or power failure condition. Fail-Secure operation is the proper choice for freeway management applications where it is undesirable for the detector to output a “vehicle detect” condition for a loop failure condition. A vehicle detect condition on a freeway would be considered a stalled vehicle.

The Reno A&E Model 222S detector is designed and manufactured using the latest available technology in electronic design and manufacturing; thus providing the highest possible performance and reliability. Once properly installed a Reno A&E loop detector will provide years of trouble free operation.

Section 8 Maintenance and Troubleshooting

The Reno A & E Model 222S Detector requires no maintenance. If you are having problems with your Model 222S detector, use the troubleshooting chart below to help determine the cause of the problem.

Symptom	Where To Start
No LEDs lit and detector does not respond to traffic.	See Troubleshooting Power Problems . Check for sensitivity set extremely low (0 to 2).
All Channels show CALL indication and cannot be turned OFF, even when the channel is disabled.	Check the RESET line (Pin C). The detector is being continually reset.
LOOP FAIL indication.	See Troubleshooting Loop Fail Problems .
LOOP FAIL indication (flashing 3 times per second) and detector appears to be working correctly.	See Troubleshooting Intermittent Loop Fail Problems .
Detector intermittently stays in the Call state.	See Troubleshooting Intermittent Detector Lock Ups .

8.1 TROUBLESHOOTING POWER PROBLEMS

Do any of the LEDs blink ON when the detector is powered up and a vehicle is over one of the loops connected to the detector?

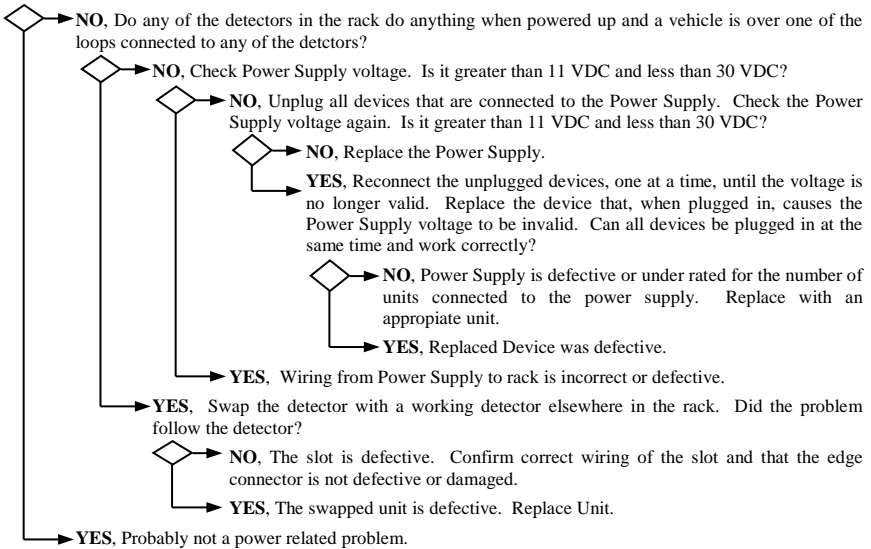

8.2 TROUBLESHOOTING LOOP FAIL PROBLEMS

Is one of the two front panel LEDs showing a Loop Failure indication?

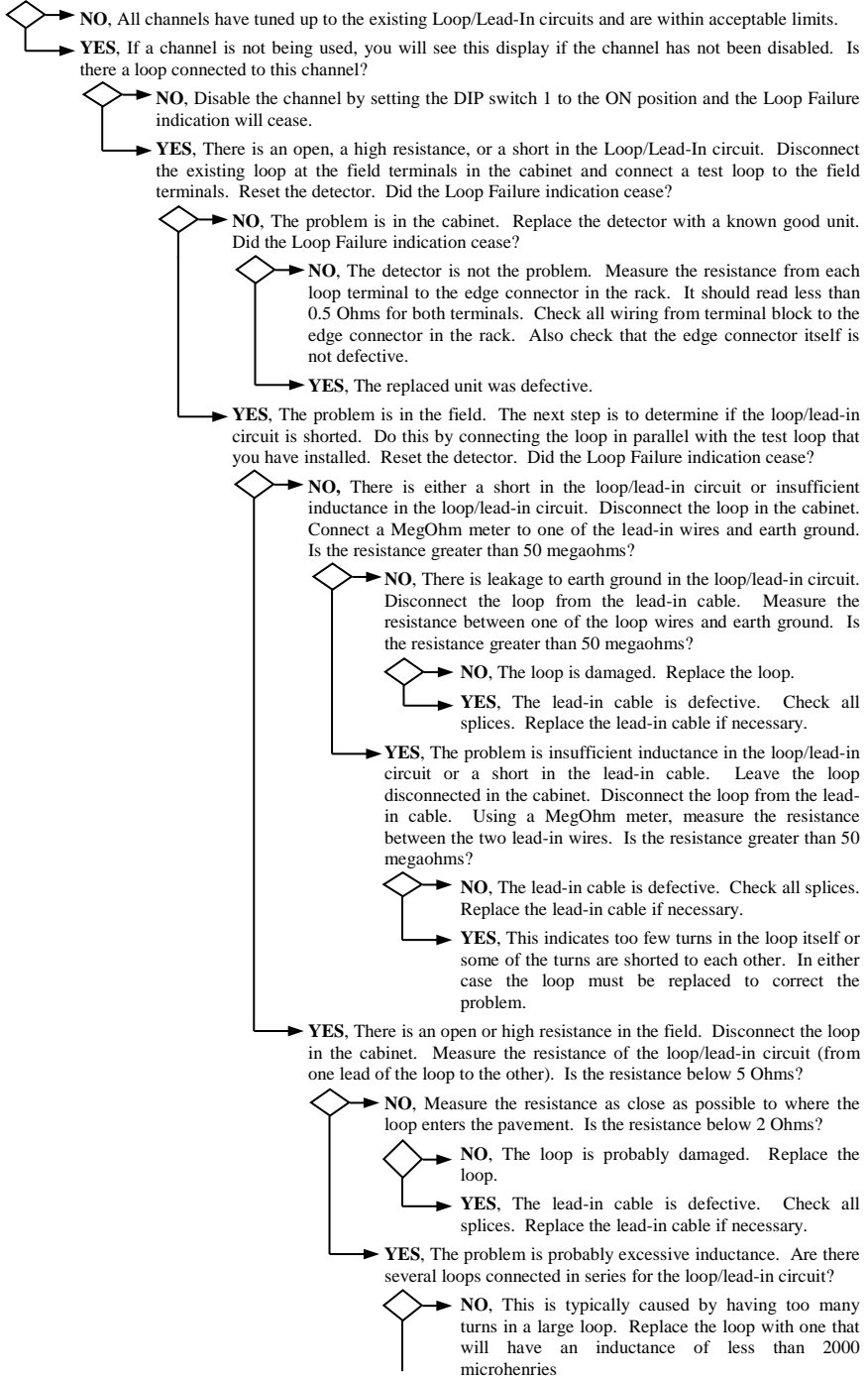

- **YES**, If possible, connecting each loop to its own detector is preferred. Or try a parallel wiring arrangement for the loops if separate detection channels are not possible.

8.3 TROUBLESHOOTING INTERMITTENT LOOP FAIL PROBLEMS

Intermittent Loop Fail problems tend to be associated with bad splices in the Loop/Lead-In circuit, shorts in the Loop/Lead-In circuit, shorts to earth ground in the Loop/Lead-In circuit, or loose connections or bad solder joints in the signal cabinet. If you have any splices that are not soldered and sealed with an adhesive heat shrink or epoxy resin, replace the splice with one that is. Using a MegOhm meter, measure the resistance from one of the loop wires to earth ground. It should be greater than 50 megaohms. Inspect the loop. Look for exposed wires or debris pressed into the saw cut. Tighten all screw terminals in the signal cabinet that the loop circuit uses. Check solder joints in the loop circuit, especially on the rack itself. Disconnect and reconnect any connector used in the loop circuit and check for loose pins and sockets in these connectors. If your cabinet has lightning or surge suppression devices on the loop inputs in the cabinet, remove or replace them. Check for places in the field where the loop wire or lead-in cable may be pinched or chaffed. Look for wires pinched under junction box covers and where the wire enters a conduit, especially where the loop wire leaves the saw cut and enters a conduit. After checking all of the above items, you could swap out the detector but this type of failure is rarely ever the detector.

8.4 TROUBLESHOOTING INTERMITTENT DETECTOR LOCK UPS

Problems of this type tend to be difficult to isolate due to the many possible causes and the short duration of the symptom (usually less than 30 minutes). If the problem occurs more frequently in the morning or when raining, suspect a short to earth ground in the loop/lead-in circuit. This can usually be verified by testing with a MegOhm meter but not always. Vibration can also be a possible cause. Loop wires may be moving slightly in a conduit due to vibrations from truck traffic. Utility lids in the street near the loop may also be a source of problems. Insure that lids near a loop are bolted down so that they cannot move. Check that each set of loop wires is twisted together in any pull boxes and that lengths are not excessive. Inspect the loop. Look for exposed wires or debris pressed into the saw cut. Check for places in the field where the loop wire or lead-in cable may be pinched or chaffed. Look for wires pinched under junction box covers and where the wire enters a conduit, especially where the loop wire leaves the saw cut and enters a conduit. **If your cabinet has lightning or surge suppression devices on the loop inputs in the cabinet, remove or replace them.** If you have any splices that are not soldered and sealed with an adhesive heat shrink or epoxy resin, replace the splice with one that is. Solder all crimp connections in the loop circuit. Tighten all screw terminals in the signal cabinet that the loop circuit uses. Check solder joints in the loop circuit, especially on the harness itself. Disconnect and reconnect any connector used in the loop circuit and check for loose pins and sockets in these connectors.

8.5 TEST MODE OPERATION

The Test Mode uses the microcontroller to verify the proper operation of the entire detector's input and output circuitry including switches, LEDs, and outputs. Each channel's loop oscillator circuit is also checked to verify the correct frequency in each of the four frequency selections. The frequency portion of the test requires each channel to be connected to a 100 microhenry loop. If an inductance value other than 100 microhenries is used, the frequency test results will be invalid. NOTE: The test procedures outlined below should not be performed in an operational traffic signal cabinet.

All test procedures outlined below contain references to individual components and groups of components that are verified when the various tests are performed. The following table lists the components in each group.

Component Group	Group Description	Group Components
A	Microprocessor	C17, C18, U7, X1
B	Test Switches	R34, R35, R36, R37, R38, R48, R49, R50, RP1, RP2, RP3, RP4, S1, S2, S3, S4, S5, S6, SW1, SW2, U3, U8, U9, U12, U15
C	Channel 1 Relay Output	D10, Q17, RL2
D	Channel 2 Relay Output	D9, Q16, RL1
E	Channel 1 Solid State Output	Q14, Q15, R44, R45, R47, U13, U14, Z5, Z6
F	Channel 2 Solid State Output	Q12, Q13, R42, R43, R46, U13, U14, Z3, Z4
G	Channel 1 Oscillator Circuit	C9, C10, C11, C12, C13, LA1, Q1, Q2, Q3, Q4, R6, R7, R12, R13, R14, R15, T1, TZ1
H	Channel 2 Oscillator Circuit	C14, C15, C16, C21, C22, LA2, Q5, Q6, Q7, Q8, R23, R24, R25, R26, R31, R32, T2, TZ2
I	Oscillator Detect Circuit	D6, D7, R16, R27, R28, R29, R30, R33, U4, U5, U6
J	Reset Circuit	C4, C6, D3, R4, R5, R17, R18, R20, R21, R22, U4

Test Procedure (Front Panel DIP switches):

- STEP 1. Remove power from the detector.

- STEP 2. Set all Front Panel DIP switches (SW1 & SW2) to the “OFF” position.
- STEP 3. Set both Front Panel Test Toggle switches (SW3 & SW4) to the “NORM (center) position.
- STEP 4. Set switch 1 of the four position DIP switch module S3, located near the upper right corner of the PC board, to the “ON” position.
- STEP 5. Set switch 2 of the four position DIP switch module S3, located near the upper right corner of the PC board, to the “OFF” position.
- STEP 6. Insert the detector into a suitable test fixture and apply power. All the LED indicators should be OFF. **NOTE: To test the frequency range, the channel must be connected to a 100 microhenry loop.** The other tests may be performed with any loops within the range of 20 to 2000 microhenries.
- STEP 7. Individually, turn ON switches 8, 7, 6, 5, 4, and 1 of the Channel 1 Front Panel DIP switch module (SW1). Turn OFF each switch after verifying the results indicated in the table below.

Switch Label	Switch #	Detector LED Indication	Components and Component Groups Verified
“SENSE LEVEL 4”	8	CH 1 LED ON (GREEN)	SW1-P8, LED1, R3, A, B
“SENSE LEVEL 2”	7	CH 2 LED ON (GREEN)	SW1-P7, LED2, R39, A, B
“SENSE LEVEL 1”	6	CH 1 LED ON (RED)	SW1-P6, LED1, R3, A, B
“PRES PULS”	5	CH 2 LED ON (RED)	SW1-P5, LED2, R39, A, B
“FAIL SAFE”	4	CH 1 LED ON (GREEN)	SW1-P4, LED1, R3, A, B
“DISABLE”	1	CH 2 LED ON (GREEN)	SW1-P1, LED2, R39, A, B

- STEP 8. Individually, turn ON switches 8, 7, 6, 5, 4, and 1 of the Channel 2 Front Panel DIP switch module (SW2). Turn OFF each switch after verifying the results indicated in the table below.

Switch Label	Switch #	Detector LED Indication	Components and Component Groups Verified
“SENSE LEVEL 4”	8	CH 1 LED ON (GREEN)	SW2-P8, LED1, R3, A, B
“SENSE LEVEL 2”	7	CH 2 LED ON (GREEN)	SW2-P7, LED2, R39, A, B
“SENSE LEVEL 1”	6	CH 1 LED ON (RED)	SW2-P6, LED1, R3, A, B
“PRES PULS”	5	CH 2 LED ON (RED)	SW2-P5, LED2, R39, A, B
“FAIL SAFE”	4	CH 1 LED ON (GREEN)	SW2-P4, LED1, R3, A, B
“DISABLE”	1	CH 2 LED ON (GREEN)	SW2-P1, LED2, R39, A, B

Test Procedure (Operating Frequencies):

- STEP 1. Remove power from the detector.
- STEP 2. Set all Front Panel DIP switches (SW1 & SW2) to the “OFF” position.
- STEP 3. Set both Front Panel Test Toggle switches (SW3 & SW4) to the “NORM (center) position.
- STEP 4. Set switches 1 and 2 of the four position DIP switch module S3, located near the upper right corner of the PC board, to the “ON” position.
- STEP 5. Insert the detector into a suitable test fixture and apply power. All the LED indicators should be OFF. **NOTE: To test the frequency range, the channel must be connected to a 100 microhenry loop.** The other tests may be performed with any loops within the range of 20 to 2000 microhenries.
- STEP 6. Individually, turn ON switches 3 & 2 of the Channel 1 Front Panel DIP switch module (SW1) and verify the results indicated in the table below.

Switch Label	Switch #	Detector LED Indication	Components and Component Groups Verified
“FREQ 1”	3	CH 1 LED ON (GREEN)	SW1-P3, LED1, R3, A, G, I
“FREQ 2”	2	CH 1 LED ON (GREEN) CH 2 LED ON (GREEN)	SW1-P2, LED 1, LED2, R3, R39, A, G, I

- STEP 7. Individually, turn OFF switches 3 & 2 of the Channel 1 Front Panel DIP switch module (SW1). The Channel 1 and Channel 2 LEDs should both turn OFF only after both switches have been turned OFF.
- STEP 8. Individually, turn ON switches 3 & 2 of the Channel 2 Front Panel DIP switch module (SW2) and verify the results indicated in the table below.

Switch Label	Switch #	Detector LED Indication	Components and Component Groups Verified
“FREQ 1”	3	CH 1 LED ON (RED)	SW2-P3, LED1, R3, A, H, I
“FREQ 2”	2	CH 1 LED ON (RED) CH 2 LED ON (RED)	SW2-P2, LED1, LED 2, R3, R39, A, H, I

- STEP 9. Individually, turn OFF switches 3 & 2 of the Channel 2 Front Panel DIP switch module (SW2). The Channel 1 and Channel 2 FAIL LEDs should both turn OFF only after both switches have been turned OFF.

Test Procedure (Detector Outputs):

- STEP 1. Remove power from the detector.
- STEP 2. Refer to the table in Section 3.5 and set all Front Panel DIP switches (SW1 & SW2) to their default positions.
- STEP 3. Set both Front Panel Test Toggle switches (SW3 & SW4) to the “NORM (center) position.

- STEP 4. Set switches 1 and 2 of the four position DIP switch module S3, located near the upper right corner of the PC board, to the "OFF" position.
- STEP 5. Insert the detector into a suitable test fixture and apply power. All the LED indicators should be OFF. **NOTE: To test the frequency range, the channel must be connected to a 100 microhenry loop.** The other tests may be performed with any loops within the range of 20 to 2000 microhenries.
- STEP 6. Perform the actions and verify the results indicated in the table below. NOTE: Unless otherwise noted, references to switches, buttons, or inputs in the table correspond to labels on test equipment supplied by Reno A & E.

Switch / Button / Input	Action	LED Indications and Outputs	Components and Component Groups Verified
CH 1 LOOP ("LOOP A")	INPUT CALL	DETECTOR CH 1 LED ON (GREEN) TEST BOX CH 1 DETECT LED ON	LED1, R3, A, B, C (Relay Outputs) or E (Solid State Outputs) G, I
CH 1 LOOP ("LOOP A")	REMOVE CALL	DETECTOR CH 1 LED OFF TEST BOX CH 1 DETECT LED OFF	LED1, R3, A, B, C (Relay Outputs) or E (Solid State Outputs) G, I
CH 2 LOOP ("LOOP B")	INPUT CALL	DETECTOR CH 2 LED ON (GREEN) TEST BOX CH 2 DETECT LED ON	LED2, R39, A, B, D (Relay Outputs) or F (Solid State Outputs) G, I
CH 2 LOOP ("LOOP B")	REMOVE CALL	DETECTOR CH 2 LED OFF TEST BOX CH 2 DETECT LED OFF	LED2, R39, A, B, D (Relay Outputs) or F (Solid State Outputs) G, I
DETECTOR CH 1 TEST TOGGLE SWITCH	TOGGLE SWITCH "CALL"	TEST BOX CH 1 DETECT LED ON	SW3
DETECTOR CH 1 TEST TOGGLE SWITCH	TOGGLE SWITCH "NORM"	TEST BOX CH 1 DETECT LED OFF	SW3
DETECTOR CH 1 TEST TOGGLE SWITCH	TOGGLE SWITCH "TEST"	TEST BOX CH 1 DETECT LED ON	SW3
DETECTOR CH 1 TEST TOGGLE SWITCH	TOGGLE SWITCH "NORM"	TEST BOX CH 1 DETECT LED OFF	SW3
DETECTOR CH 2 TEST TOGGLE SWITCH	TOGGLE SWITCH "CALL"	TEST BOX CH 2 DETECT LED ON	SW4
DETECTOR CH 2 TEST TOGGLE SWITCH	TOGGLE SWITCH "NORM"	TEST BOX CH 2 DETECT LED OFF	SW4
DETECTOR CH 2 TEST TOGGLE SWITCH	TOGGLE SWITCH "TEST"	TEST BOX CH 2 DETECT LED ON	SW4
DETECTOR CH 2 TEST TOGGLE SWITCH	TOGGLE SWITCH "NORM"	TEST BOX CH 2 DETECT LED OFF	SW4

8.6

8.7 VOLTAGE AND WAVEFORM MEASUREMENTS

The following voltage and waveform measurements are referenced to logic ground on Contact A of the edge card connector.

VOLTAGES:

1. Verify 10.8 to 30 VDC on Contact B of the edge card connector.
2. Verify 5 VDC on the following:
Pin 3 of U1 (regulator)
Pin 3 of U10 (regulator)
Pin 1 (Reset) and Pin 20 (VCC) of U7 (microcontroller).
3. Verify channel 1 and 2 oscillator sine wave (shown in Figure 1) forms across LA1 and LA2 (surge protectors). The sine wave should be 8 to 10 Vp-p and between 20 and 100 kHz.
4. Verify channel 1 and 2 oscillator scan signals (shown in Figure 2) on Pins 2 and 3 of U7 respectively.
5. Verify the comparator square wave on Pin 5 of U4 (Figure 3). Turn OFF one of the channels with the front panel DISABLE switch to verify the operation of the other channel.
6. Verify the operation of the crystal on Pin 10 of U7 (Figure 4).

WAVE FORMS:

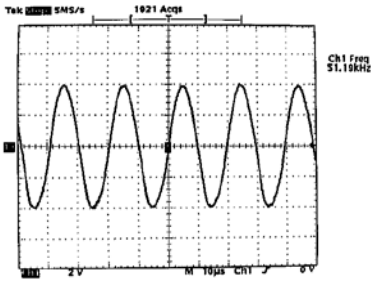

Figure 1.

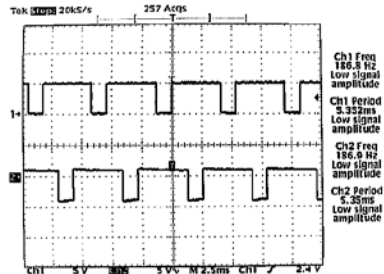

Figure 2.



Figure 3.

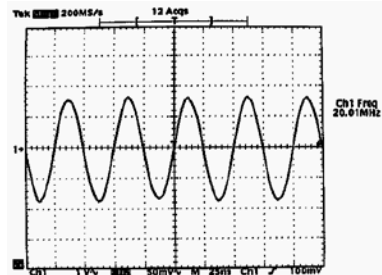

Figure 4.

8.8 THINGS TO KNOW ABOUT LOOPS

Always use a wire with cross-linked Polyethylene insulation (insulation type XLPE) for loop wire.

Typical sensing height is $\frac{2}{3}$ of the shortest leg of a loop. Therefore, a 6' x 6' loop will have a detection height of 4'.

The inductance of a conventional four-sided loop can be estimated using the formula:

$$L = P \times (T^2 + T) / 4$$

Where: L = Loop Inductance in microhenries
 P = Loop Perimeter in feet
 T = Number of Wires in Slot

Therefore, a 6' by 6' loop with 3 turns would have an inductance of:

$$\begin{aligned} L &= (6 + 6 + 6 + 6) \times (3^2 + 3) / 4 \\ L &= 24 \times (9 + 3) / 4 \\ L &= 24 \times 12 / 4 \\ L &= 24 \times 3 \\ L &= 72 \text{ microhenries.} \end{aligned}$$

The inductance of a Quadrupole™ loop can be estimated using the formula:

$$L = [P \times (T^2 + T) / 4] + [CL \times (T^2 + T) / 4]$$

Where: L = Loop Inductance in microhenries
 P = Loop Perimeter in feet
 T = Number of Wires in Slot
 CL = Length of Center Leg in feet.

Therefore, a 6' by 50' loop with a 2-4-2 configuration would have an inductance of:

$$\begin{aligned} L &= [(6 + 50 + 6 + 50) \times (2^2 + 2) / 4] + [50 \times (4^2 + 4) / 4] \\ L &= [112 \times (4 + 2) / 4] + [50 \times (16 + 4) / 4] \\ L &= (112 \times 6 / 4) + (50 \times 20 / 4) \\ L &= (112 \times 1.5) + (50 \times 5) \\ L &= 168 + 250 \\ L &= 418 \text{ microhenries.} \end{aligned}$$

Loop Feeder cable typically adds 0.22 microhenries of inductance per foot of cable.

Total inductance of loops connected in series: $L_{\text{TOTAL}} = L_1 + L_2 + L_3 + \dots + L_N$.

Total inductance of loops connected in parallel: $L_{\text{TOTAL}} = 1 / [(1 / L_1) + (1 / L_2) + (1 / L_3) + \dots + (1 / L_N)]$.

Section 9 Schematic

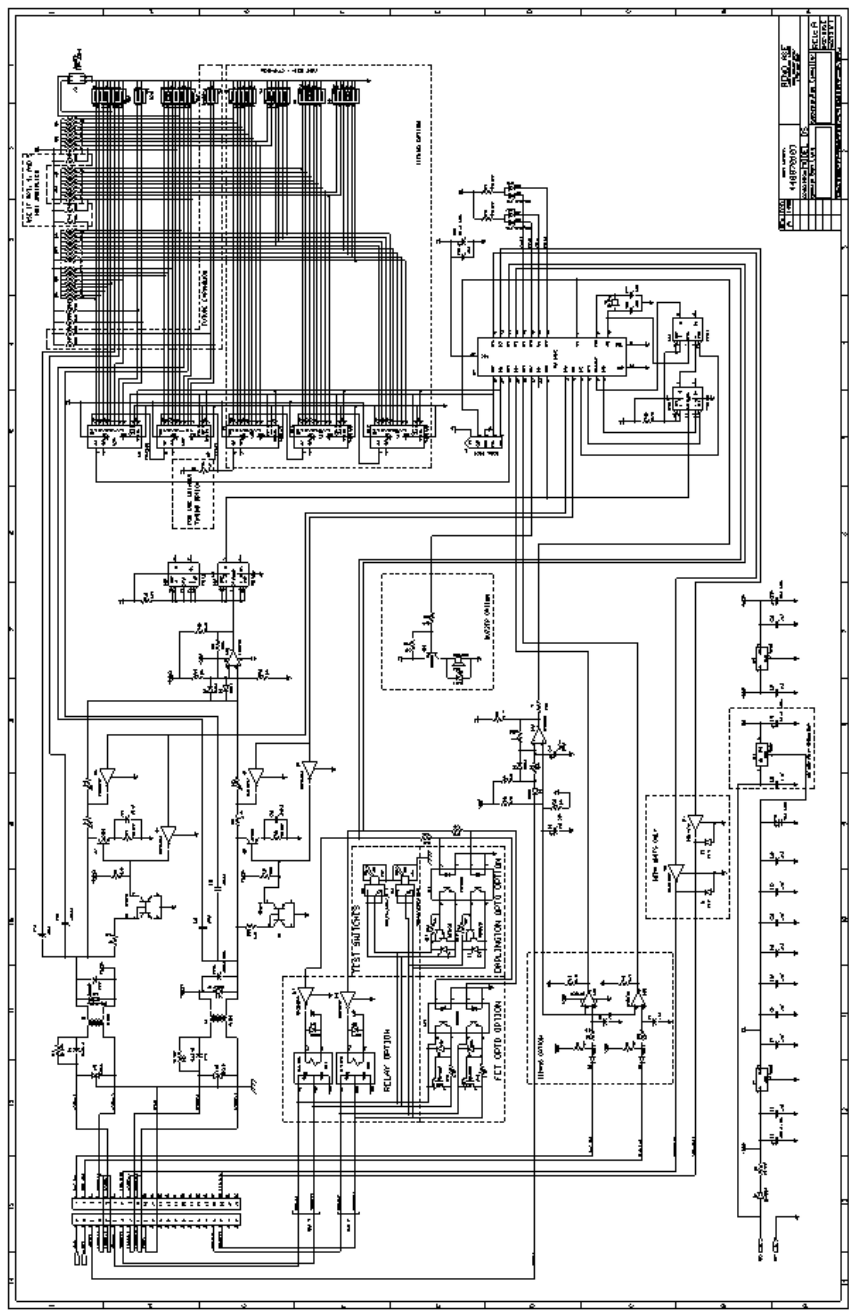

Section 10 PCB Layout

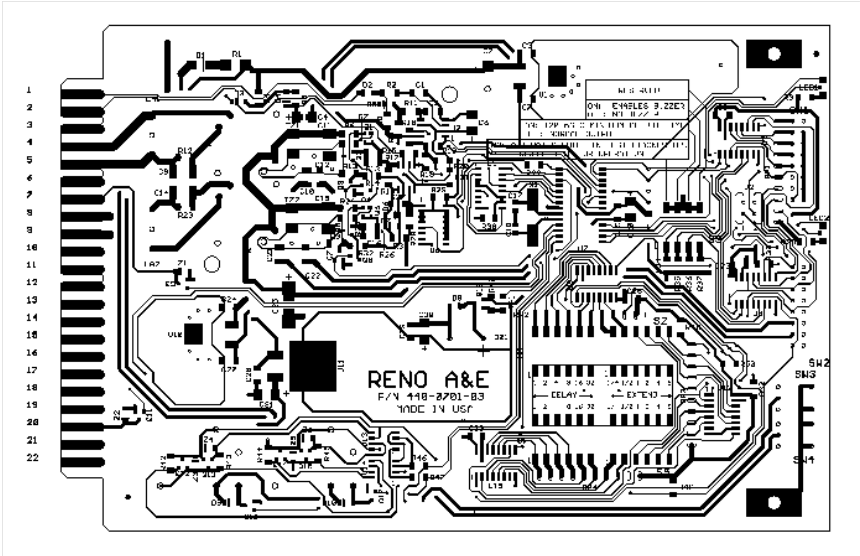

Top View

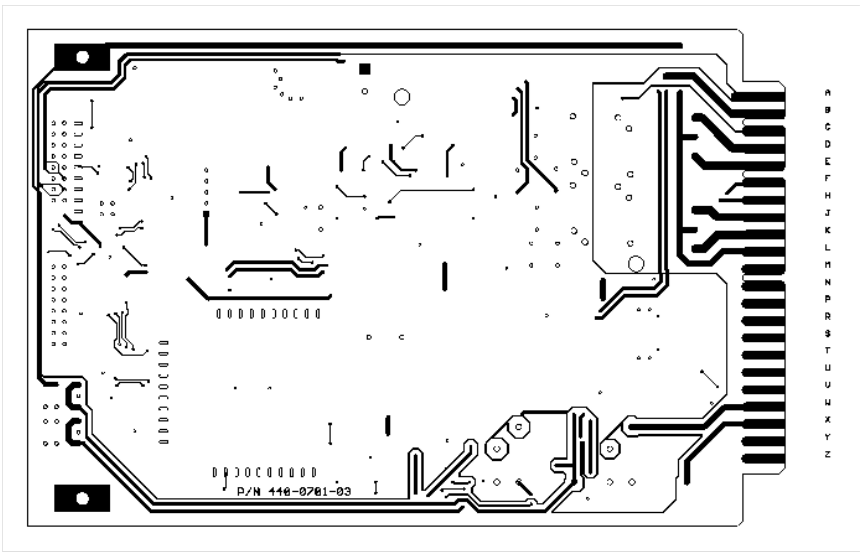

Bottom View

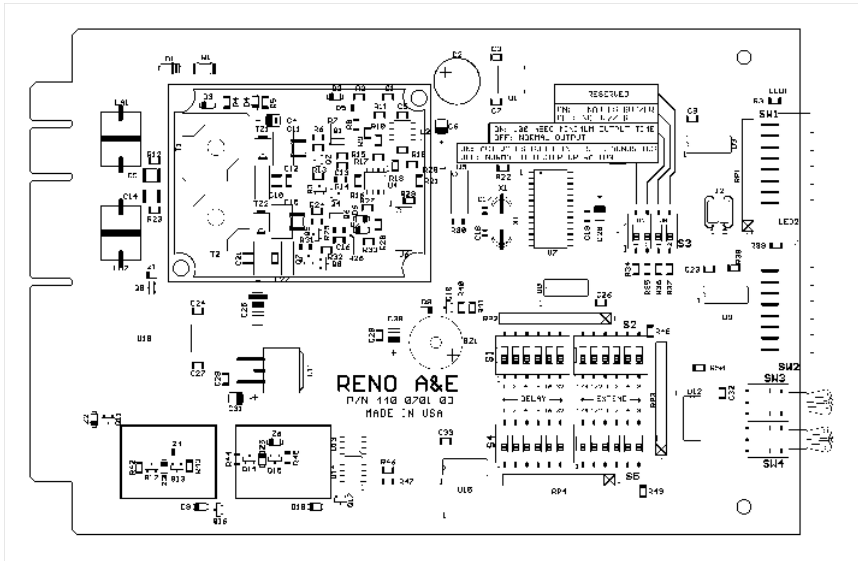

Parts Locator

Section 11 Parts List

SMT denotes a Surface Mount Device, TH denotes a Through Hole device.

Part	Part Number	Description	SMT	TH	Model 222S, SS Solid State Outputs w/o Buzzer 400-0753-01	Model 222S-R Relay Outputs w/o Buzzer 400-0753-01	Model 222SBR-SS Solid State Outputs 400-0753-00	Model 222SBR-R Relay Outputs w/ Buzzer 400-0753-00
PCB	440-0701-03	PC Board, GS			X	X	X	X
BZ1	357-7006-00	TH MAGNETIC BUZZER		X			X	X
C1	020-0104-00	SMT CAPICTOR, X7R, 0.1µF, 50V	X					
C2	226-0477-00	TH CAPACITOR, ELECTROLYTIC, 470µF, 35V		X	X	X	X	X
C3	020-0104-00	SMT CAPACITOR, X7R, 0.1µF, 50V	X		X	X	X	X
C4	022-0271-00	SMT CAPACITOR, NPO, 270pF, 0805	X		X	X	X	X
C5	020-0104-00	SMT CAPACITOR, X7R, 0.1µF, 50V	X					
C6	025-0105-00	SMT CAPACITOR, TANTALUM, 1µF, 35V, B PACKAGE	X		X	X	X	X
C7	020-0104-00	SMT CAPACITOR, X7R, 0.1µF, 50V	X		X	X	X	X
C8	020-0104-00	SMT CAPACITOR, X7R, 0.1µF, 50V	X		X	X	X	X
C9	020-0684-00	SMT CAPACITOR, X7R, 0.68µF, 50V	X		X	X	X	X
C10	021-0223-00	SMT CAPACITOR, PPS, 0.022µF -OR-	X		X	X	X	X
	220-0223-00	TH CAPACITOR, METALIZED POLYPROPYLENE, 0.022µF, 100V		X				
C11	021-0683-00	SMT CAPACITOR, PPS, 0.01µF -OR-	X		X	X	X	X
	220-0683-00	TH CAPACITOR, METALIZED POLYPROPYLENE, 0.01µF,		X				
C12	021-0103-00	SMT CAPACITOR, PPS, 0.01µF -OR-	X		X	X	X	X
	220-0103-00	TH CAPACITOR, METALIZED POLYPROPYLENE, 0.01µF,		X				
C13	020-0683-00	SMT CAPACITOR, X7R, 0.068µF, 50V	X		X	X	X	X
C14	020-0684-00	SMT CAPACITOR, X7R, 0.68µF, 50V	X		X	X	X	X
C15	021-0683-00	SMT CAPACITOR, PPS, 0.01µF -OR-	X		X	X	X	X
	220-0683-00	TH CAPACITOR, METALIZED POLYPROPYLENE, 0.01µF,		X				
C16	020-0683-00	SMT CAPACITOR, X7R, 0.068µF, 50V	X		X	X	X	X
C17	022-0220-00	SMT CAPACITOR, NPO, 22pF, 0805	X		X	X	X	X
C18	022-0220-00	SMT CAPACITOR, NPO, 22pF, 0805	X		X	X	X	X
C19	020-0104-00	SMT CAPICTOR, X7R, 0.1µF, 50V	X		X	X	X	X
C20	025-0106-00	SMT CAPACITOR, TANTALUM, 10µF, 16V, B PACKAGE	X		X	X	X	X
C21	021-0223-00	SMT CAPACITOR, PPS, 0.022µF -OR-	X		X	X	X	X
	220-0223-00	TH CAPACITOR, METALIZED POLYPROPYLENE, 0.022µF,		X				
C22	021-0103-00	SMT CAPACITOR, PPS, 0.01µF -OR-	X		X	X	X	X
	220-0103-00	TH CAPACITOR, METALIZED POLYPROPYLENE, 0.01µF,		X				
C23	020-0104-00	SMT CAPICTOR, X7R, 0.1µF, 50V	X		X	X	X	X
C24	020-0104-00	SMT CAPICTOR, X7R, 0.1µF, 50V	X		X	X	X	X
C25	025-0106-00	SMT CAPACITOR, TANTALUM, 10µF, 16V, B PACKAGE	X		X	X	X	X
C26	020-0104-00	SMT CAPICTOR, X7R, 0.1µF, 50V	X		X	X	X	X
C27	020-0104-00	SMT CAPICTOR, X7R, 0.1µF, 50V	X		X	X	X	X
C28	020-0104-00	SMT CAPICTOR, X7R, 0.1µF, 50V	X			X		X
C29	020-0104-00	SMT CAPICTOR, X7R, 0.1µF, 50V	X		X	X	X	X
C30	025-0106-00	SMT CAPACITOR, TANTALUM, 10µF, 16V, B PACKAGE	X		X	X	X	X
C31	025-0106-00	SMT CAPACITOR, TANTALUM, 10µF, 16V, B PACKAGE	X			X		X
C32	020-0104-00	SMT CAPICTOR, X7R, 0.1µF, 50V	X		X	X	X	X
C33	020-0104-00	SMT CAPICTOR, X7R, 0.1µF, 50V	X		X	X	X	X
D1	064-4004-00	SMT DIODE, POWER, RECTIFIER, SMA	X		X	X	X	X
D2	060-1914-00	SMT DIODE, SMALL SIGNAL, SOD123	X					
D3	060-1914-00	SMT DIODE, SMALL SIGNAL, SOD123	X		X	X	X	X
D4	060-1914-00	SMT DIODE, SMALL SIGNAL, SOD123	X					
D5	060-1914-00	SMT DIODE, SMALL SIGNAL, SOD123	X					
D6	060-1914-00	SMT DIODE, SMALL SIGNAL, SOD123	X		X	X	X	X
D7	060-1914-00	SMT DIODE, SMALL SIGNAL, SOD123	X		X	X	X	X
D8	060-1914-00	SMT DIODE, SMALL SIGNAL, SOD123	X				X	X
D9	060-1914-00	SMT DIODE, SMALL SIGNAL, SOD123	X			X		X
D10	060-1914-00	SMT DIODE, SMALL SIGNAL, SOD123	X			X		X
LA1	349-0004-00	TH TRANSIENT PROTECTION, SPARK GAP, 3 PRONG		X	X	X	X	X
LA2	349-0004-00	TH TRANSIENT PROTECTION, SPARK GAP, 3 PRONG		X	X	X	X	X
LED1	141-0000-00	SMT LED, RED/GREEN	X		X	X	X	X
LED2	141-0000-00	SMT LED, RED/GREEN	X		X	X	X	X

Part	Part Number	Description	SMT	TH	Model 222S-SS Solid State Outputs w/o Buzzer 400-09753-01	Model 222S-SS Relay Outputs w/o Buzzer 400-09754-01	Model 222S-SS Solid State Outputs w/o Buzzer 400-09755-00	Model 222S-SS-RR Relay Outputs w/ Buzzer 400-09756-00
Q1	044-0005-00	SMT TRANSISTOR, COMMON BASE, ARRAY, NPN, PAIR	X		X	X	X	X
Q2	040-3904-00	SMT TRANSISTOR, SMALL SIGNAL, NPN, SOT23	X		X	X	X	X
Q3	041-0002-00	SMT TRANSISTOR, DRIVER, NPN, SOT23, DTC	X		X	X	X	X
Q4	041-0002-00	SMT TRANSISTOR, DRIVER, NPN, SOT23, DTC	X		X	X	X	X
Q5	040-3904-00	SMT TRANSISTOR, SMALL SIGNAL, NPN, SOT23	X		X	X	X	X
Q6	044-0005-00	SMT TRANSISTOR, COMMON BASE, ARRAY, NPN, PAIR	X		X	X	X	X
Q7	041-0002-00	SMT TRANSISTOR, DRIVER, NPN, SOT23, DTC	X		X	X	X	X
Q8	041-0002-00	SMT TRANSISTOR, DRIVER, NPN, SOT23, DTC	X		X	X	X	X
Q9	041-0002-00	SMT TRANSISTOR, DRIVER, NPN, SOT23, DTC	X					
Q10	040-3906-00	SMT TRANSISTOR, SMALL SIGNAL, PNP, SOT23	X				X	X
Q11	041-0002-00	SMT TRANSISTOR, DRIVER, NPN, SOT23, DTC	X					
Q12	042-0001-00	SMT TRANSISTOR, DARLINGTON, NPN, SOT23	X		X		X	
Q13	043-0000-00	SMT TRANSISTOR, FET, P-CHANNEL, SOT23	X					
Q14	042-0001-00	SMT TRANSISTOR, DARLINGTON, NPN, SOT23	X		X		X	
Q15	043-0000-00	SMT TRANSISTOR, FET, P-CHANNEL, SOT23	X					
Q16	041-0002-00	SMT TRANSISTOR, DRIVER, NPN, SOT23, DTC	X			X		X
Q17	041-0002-00	SMT TRANSISTOR, DRIVER, NPN, SOT23, DTC	X			X		X
R1	002-0100-00	SMT RESISTOR, 2010, 10 OHM	X		X	X	X	X
R2	001-0123-00	SMT RESISTOR, 1206, 12K OHM	X					
R3	001-0511-00	SMT RESISTOR, 1206, 510 OHM	X		X	X	X	X
R4	001-0103-00	SMT RESISTOR, 1206, 10K OHM	X		X	X	X	X
R5	001-0123-00	SMT RESISTOR, 1206, 12K OHM	X		X	X	X	X
R6	001-0302-00	SMT RESISTOR, 1206, 3.0K OHM	X		X	X	X	X
R7	001-0362-00	SMT RESISTOR, 1206, 3.6K OHM	X		X	X	X	X
R8	001-0103-00	SMT RESISTOR, 1206, 10K OHM	X					
R9	001-0103-00	SMT RESISTOR, 1206, 10K OHM	X					
R10	001-0472-00	SMT RESISTOR, 1206, 4.7K OHM	X					
R11	001-0123-00	SMT RESISTOR, 1206, 12K OHM	X					
R12	001-0390-00	SMT RESISTOR, 1206, 39 OHM	X		X	X	X	X
R13	001-0242-00	SMT RESISTOR, 1206, 2.4K OHM	X		X	X	X	X
R14	001-0243-00	SMT RESISTOR, 1206, 24K OHM	X		X	X	X	X
R15	001-0680-00	SMT RESISTOR, 1206, 68 OHM	X		X	X	X	X
R16	001-0243-00	SMT RESISTOR, 1206, 24K OHM	X		X	X	X	X
R17	000-0000-00	OMITTED PART						
R18	001-0472-00	SMT RESISTOR, 1206, 4.7K OHM	X		X	X	X	X
R19	001-0472-00	SMT RESISTOR, 1206, 4.7K OHM	X					
R20	001-0243-00	SMT RESISTOR, 1206, 24K OHM	X		X	X	X	X
R21	001-0243-00	SMT RESISTOR, 1206, 24K OHM	X		X	X	X	X
R22	001-0102-00	SMT RESISTOR, 1206, 1K OHM	X		X	X	X	X
R23	001-0390-00	SMT RESISTOR, 1206, 39 OHM	X		X	X	X	X
R24	001-0302-00	SMT RESISTOR, 1206, 3.0K OHM	X		X	X	X	X
R25	001-0362-00	SMT RESISTOR, 1206, 3.6K OHM	X		X	X	X	X
R26	001-0680-00	SMT RESISTOR, 1206, 68 OHM	X		X	X	X	X
R27	001-0394-00	SMT RESISTOR, 1206, 390K OHM	X		X	X	X	X
R28	001-0162-00	SMT RESISTOR, 1206, 1.6K OHM	X		X	X	X	X
R29	001-0472-00	SMT RESISTOR, 1206, 4.7K OHM	X		X	X	X	X
R30	001-0472-00	SMT RESISTOR, 1206, 4.7K OHM	X		X	X	X	X
R31	001-0242-00	SMT RESISTOR, 1206, 2.4K OHM	X		X	X	X	X
R32	001-0243-00	SMT RESISTOR, 1206, 24K OHM	X		X	X	X	X
R33	001-0273-00	SMT RESISTOR, 1206, 27K OHM	X		X	X	X	X
R34	001-0103-00	SMT RESISTOR, 1206, 10K OHM	X		X	X	X	X
R35	001-0103-00	SMT RESISTOR, 1206, 10K OHM	X		X	X	X	X
R36	001-0103-00	SMT RESISTOR, 1206, 10K OHM	X		X	X	X	X
R37	001-0103-00	SMT RESISTOR, 1206, 10K OHM	X		X	X	X	X
R38	001-0123-00	SMT RESISTOR, 1206, 12K OHM	X		X	X	X	X
R39	001-0511-00	SMT RESISTOR, 1206, 510 OHM	X		X	X	X	X

Part	Part Number	Description	SMT	TH	Model 222S, SS Solid State Outputs w/o Buzzer 400-0753-01	Model 222S-RB Relay Outputs w/o Buzzer 400-0754-01	Model 222S-BSS Solid State Outputs w/o Buzzer 400-0755-00	Model 222S-BR Relay Outputs w/ Buzzer 400-0756-00
R40	001-0243-00	SMT RESISTOR, 1206, 24K OHM	X				X	X
R41	001-0362-00	SMT RESISTOR, 1206, 3.6K OHM	X				X	X
R42	001-0563-00	SMT RESISTOR, 1206, 56K OHM	X		X		X	
R43	001-0105-00	SMT RESISTOR, 1206, 1.0M OHM	X					
R44	001-0563-00	SMT RESISTOR, 1206, 56K OHM	X		X		X	
R45	001-0105-00	SMT RESISTOR, 1206, 1.0M OHM	X					
R46	001-0162-00	SMT RESISTOR, 1206, 1.6K OHM	X		X		X	
R47	001-0162-00	SMT RESISTOR, 1206, 1.6K OHM	X		X		X	
R48	001-0103-00	SMT RESISTOR, 1206, 10K OHM	X		X	X	X	X
R49	001-0103-00	SMT RESISTOR, 1206, 10K OHM	X		X	X	X	X
R50	001-0103-00	SMT RESISTOR, 1206, 10K OHM	X		X	X	X	X
RL1	350-0012-00	TH RELAY, 12VDC, SENSITIVE, AZ8		X		X		X
RL2	350-0012-00	TH RELAY, 12VDC, SENSITIVE, AZ8		X		X		X
RP1	203-0103-00	TH RESISTOR, NETWORK, 10K OHM, SIP, 9 RESISTOR		X	X	X	X	X
RP2	203-0103-00	TH RESISTOR, NETWORK, 10K OHM, SIP, 9 RESISTOR		X				
RP3	203-0103-00	TH RESISTOR, NETWORK, 10K OHM, SIP, 9 RESISTOR		X				
RP4	203-0103-00	TH RESISTOR, NETWORK, 10K OHM, SIP, 9 RESISTOR		X				
S1	121-0006-00	SMT SWITCH, DIP, 6 POSITION, FACE UP	X					
S2	121-0006-00	SMT SWITCH, DIP, 6 POSITION, FACE UP	X					
S3	121-0002-00	SMT SWITCH, DIP, 2 POSITION, FACE UP	X		X	X		
	121-0004-00	SMT SWITCH, DIP, 4 POSITION, FACE UP	X				X	X
S4	121-0006-00	SMT SWITCH, DIP, 6 POSITION, FACE UP	X					
S5	121-0006-00	SMT SWITCH, DIP, 6 POSITION, FACE UP	X					
SW1	321-0008-00	TH SWITCH, DIP, 8 POSITION, RIGHT ANGLE		X	X	X	X	X
SW2	321-0008-00	TH SWITCH, DIP, 8 POSITION, RIGHT ANGLE		X	X	X	X	X
SW3	322-0006-00	TH SWITCH, TOGGLE, RIGHT ANGLE, TINY, ON-OFF-MOM		X	X	X	X	X
SW4	322-0006-00	TH SWITCH, TOGGLE, RIGHT ANGLE, TINY, ON-OFF-MOM		X	X	X	X	X
T1	348-1002-02	TH TRANSFORMER, ISOLATION, POTCORE, AL800, GRADE		X	X	X	X	X
T2	348-1002-02	TH TRANSFORMER, ISOLATION, POTCORE, AL800, GRADE		X	X	X	X	X
TZ1	068-0075-00	SMT DIODE, TRANZORB, 7.5V, SMB	X		X	X	X	X
TZ2	068-0075-00	SMT DIODE, TRANZORB, 7.5V, SMB	X		X	X	X	X
U1	094-0402-00	SMT LINEAR IC, REGULATOR, 78M05	X		X	X	X	X
U2	094-0201-00	SMT LINEAR IC, COMPARATOR, LM393	X					
U3	095-0000-00	SMT DIGITAL IC, LOGIC, 74HC165N, SOIC, 8-BIT	X		X	X	X	X
U4	094-0201-00	SMT LINEAR IC, COMPARATOR, LM393	X		X	X	X	X
U5	095-0700-00	SMT DIGITAL IC, LOGIC, 74HC112	X		X	X	X	X
U6	095-0700-00	SMT DIGITAL IC, LOGIC, 74HC112	X		X	X	X	X
U7	413-0702-01	SMT PROM ASSY, GS, 1.1	X		X	X	X	X
U8	095-0000-00	SMT DIGITAL IC, LOGIC, 74HC165N, SOIC, 8-BIT	X					
U9	095-0000-00	SMT DIGITAL IC, LOGIC, 74HC165N, SOIC, 8-BIT	X		X	X	X	X
U10	094-0402-00	SMT LINEAR IC, REGULATOR, 78M05	X		X	X	X	X
U11	094-0401-00	SMT LINEAR IC, REGULATOR, 7805	X			X		X
U12	095-0000-00	SMT DIGITAL IC, LOGIC, 74HC165N, SOIC, 8-BIT	X					
U13	094-0700-00	SMT LINEAR IC, OPTO COUPLER, MOC208	X					
U14	094-0700-00	SMT LINEAR IC, OPTO COUPLER, MOC208	X		X		X	
U15	095-0000-00	SMT DIGITAL IC, LOGIC, 74HC165N, SOIC, 8-BIT	X					
X1	155-0206-00 355-0206-00	SMT CRYSTAL, 20MHZ -OR- TH CRYSTAL, 20 MHZ	X		X	X		X
Z1	067-0330-00	SMT DIODE, ZENER, 33V, SOD123	X	X				
Z2	067-0330-00	SMT DIODE, ZENER, 33V, SOD123	X					
Z3	067-0330-00	SMT DIODE, ZENER, 33V, SOD123	X		X		X	
Z4	067-0180-00	SMT DIODE, ZENER, 18V, SOD123	X					
Z5	067-0330-00	SMT DIODE, ZENER, 33V, SOD123	X		X		X	
Z6	067-0180-00	SMT DIODE, ZENER, 18V, SOD123	X					