

Model Y-200 Series

Version 2.10

Operations Manual

Four Channel DIP Switch Programmable Inductive Loop Detector
Built-in Loop Analyzer for Each Channel

This manual contains technical information for the
Model Y-200 Series Loop Detector

pn 889-2502-02 Revision: April 2020



THE FOLLOWING PRODUCT WAS DESIGNED, INSPECTED, TESTED AND
MANUFACTURED IN THE USA BY EBERLE DESIGN, INC. IN PHOENIX, ARIZONA.

INFORMATION CONTAINED HEREIN IS PROPRIETARY TECHNICAL INFORMATION OF
EBERLE DESIGN, INC. PUBLICATION, REPRODUCTION OR USE IN WHOLE OR PART IS
NOT PERMITTED EXCEPT UNDER TERMS AGREED UPON IN WRITING. ALL
REGISTERED TRADEMARKS OF EBERLE DESIGN INC. ARE UNDER
© COPYRIGHT

MAINTENANCE NOTE

**IT IS AN EBERLE DESIGN, INC. RECOMMENDATION THAT EACH UNIT BE TESTED
AT LEAST ANNUALLY TO ENSURE COMPLIANCE WITH FACTORY
SPECIFICATIONS AND MEETS PROPER OPERATIONAL STANDARDS. THE
RESULTS OF THIS TESTING WILL BE DOCUMENTED.**

Model Y-200 Operations Manual

Table of Contents

Section 1 General Description.....	1
Section 2 General Characteristics.....	2
Section 3 Specifications.....	2
Section 4 User Interface.....	4
Section 5 Installation and Set-Up.....	9
Section 6 Block Diagram	9
Section 7 Theory of Operation	14
Section 8 Maintenance and Troubleshooting	16

Section 1 General Description

This Operation Manual was written for people installing, operating, and troubleshooting Reno A & E Model Y-200 inductive loop vehicle detectors. The Model Y-200 inductive loop vehicle detector is a scanning, four channel, card rack type loop detector. The Model Y-200 is designed to meet or exceed the NEMA Standards TS 2-1998 for Type B detectors and is downward compatible to NEMA Standards TS 1-1989.

The Model Y-200 uses a microcontroller to monitor and process signals from four separate loop / lead-in circuits. The operation of each channel is independently programmed with one of four front panel six-position DIP switch modules to provide the following selections:

- Seven Sensitivity Levels ($-\Delta L/L\%$) and OFF.
- Presence or Pulse Mode.
- Four Frequency Selections.

An eight-position DIP switch module mounted on the PC board provides the following functions:

- Test Mode: Used to test and verify all detector functions for proper operation.
- Filter ON / OFF: Filter ON increases the detector's immunity to noise (recommended for intersection control).
- Fail-Safe / Fail-Secure: Individual channel DIP switches to select Fail-Safe or Fail-Secure operation of the channel's output during a loop failure.
- TS 2 Channel Off Status: Used to select the state of the channel status output when the channel is disabled.

The Fail-Safe / Fail-Secure DIP switches on the PC board mounted eight-position DIP switch module select each channel's output state as Call or No Call during a loop failure condition. The Fail-Safe selection, which is the standard for intersection control, generates a continuous Call output state for as long as a loop failure condition exists. The Fail-Secure selection generates a No Call output state during a loop failure condition. For traffic control applications, such as incident detection, Fail-Secure operation is preferred because a constant Call from a failed loop appears as though traffic movement has stopped. The switch selection allows the user to set the detector to suit the application.

The Model Y-200 sequentially excites the four loop circuits. This eliminates the possibility of adjacent loop fields coupling together (crosstalk) when the loops are connected to the same detector. Each time the loop circuit is activated, loop data is obtained and recorded. The data is compared to previous samples for the amount and rate of change. A slow rate of change, as is the case with environmental drift, is continuously tracked. If a rapid change exceeds a threshold set by the sensitivity level, the output is activated.

Each channel has a single, dual color (green / red) Detect / Fail LED indicator. The LED provides an indication of the channel's output state and loop failure conditions. Output state conditions are indicated when the Detect / Fail LED is illuminated in a green state. Loop failure conditions are indicated when the Detect / Fail LED is illuminated in a red state.

If the total inductance of the loop input network goes out of the range specified for the detector, or rapidly changes by more than $\pm 25\%$, the channel will enter the programmed Fail-Safe or Fail-Secure mode of operation. The Detect / Fail LED will illuminate (red) to indicate that an Open Loop Failure or an inductance change condition of greater than $+25\%$ exists. The Detect / Fail LED will flash (red) at a one Hz rate to indicate a Shorted loop Failure or an inductance change condition of greater than -25% exists. Either indication will continue for as long as the loop failure exists. If the loop self heals, the channel will resume operation in a normal manner, except the Detect / Fail LED will flash (red) at a rate of three 50 millisecond flashes per second, thus providing an alert that a Loop Fail condition had occurred. Any prior Loop Failure indication will continue until the detector is manually reset or power is removed.

The Detect / Fail LED will illuminate (green) to indicate a vehicle presence in the loop area. If a prior Loop Failure condition had occurred and detection occurs, the Detect / Fail LED will flash (red) at a rate of three 50 millisecond flashes per second followed by a single 750 millisecond flash (green). This prior Loop Failure indication will continue until the detector is manually reset or power is removed.

In addition, the Reno A & E Model Y-200 has a Test Mode that thoroughly tests the detector module without the need for external test equipment. The Test Mode uses the microcontroller to verify the proper operation of the entire detector's input and output circuitry including switches, LEDs, and outputs. Each channel's loop oscillator circuit can also be tested to verify the correct frequency range in each of the four frequency selections.

The Model Y-200 Series is comprised of the following detectors:

- | | |
|------------------|--|
| Model Y-200-SS | For NEMA TS 2-1998 applications calling for a four channel, 2.00" wide (double width), rack mount detector with solid state outputs and an audible detect signal (buzzer). |
| Model Y/2-200-SS | For NEMA TS 2-1998 applications calling for a four channel, 1.12" wide (single width), rack mount detector with solid state outputs and an audible detect signal (buzzer). |

Section 2 General Characteristics

2.1 LOOP FREQUENCY

There are four (4) selectable loop frequency settings (normally in the range of 20 to 100 kilohertz) for each channel. The actual loop operating frequency is a function of the loop / lead-in network and the components of the loop oscillator circuit. Adjacent loops connected to different detectors may crosstalk and require changing of the operating frequency of one of the loop circuits. If crosstalk is a problem, select another loop frequency for stable operation. The four frequency selections are selected via DIP switches 1 and 2 on each of the four front panel mounted six-position DIP switch modules.

NOTE: The detector channel must be reset after changing the frequency setting.

2.2 PRESENCE/ PULSE MODE

Two modes of operation for each detector channel are available. Presence or Pulse Mode is selected by setting the state of DIP switch 3 on each of the four front panel mounted six-position DIP switch modules.

PRESENCE MODE: Provides a Call hold time of at least four minutes (regardless of vehicle size) and typically one to three hours for an automobile or truck. This is the factory default setting and the most common setting.

PULSE MODE: An output Pulse of 125 ± 10 milliseconds duration is generated for each vehicle entering the loop detection zone. Each detected vehicle is instantly tuned out if it remains in the loop detection zone longer than two seconds. This enables detection of subsequent vehicles entering the loop detection zone. After each vehicle leaves the loop detection zone, the channel resumes full sensitivity within one second.

NOTE: Changing the Presence / Pulse Mode switch setting of an individual channel will reset that channel.

2.3 SENSITIVITY

There are seven (7) selectable sensitivity levels plus OFF for each channel. The sensitivity levels are designed so that a one level increase actually doubles the sensitivity and a one level decrease halves the sensitivity. The seven sensitivity levels and OFF setting are selected via DIP switches 4, 5, and 6 on each of the four front panel mounted six-position DIP switch modules. (See Section 3.4 for actual detection levels and response times for each sensitivity level.)

NOTE: Changing the sensitivity level of an individual channel will reset that channel.

2.4 AUDIBLE DETECT SIGNAL

The pushbutton on the front panel labeled **BUZZER** is used to enable an Audible Detect Signal. When this feature is enabled (ON), an audible signal will be activated whenever the detection zone for the selected channel is occupied. The audible signal indicates actual occupancy of the loop detection zone. This feature allows a technician to watch the detection zone on the street and confirm correct detector operation without having to look at the detector front panel LEDs as well.

2.5 TEST MODE

Test Mode uses the microcontroller to verify the proper operation of the detector's controls and indicators (switches and LEDs). Each channel's loop oscillator circuit is also tested to verify the correct frequency range in each of the four frequency selections. DIP switch 3 on the PC board mounted eight-position DIP switch module is used to enable Test Mode.

NOTE: Changing the position of the Test Mode DIP switch will reset the detector.

2.6 TS 2 CHANNEL OFF STATUS

When DIP switch 2 on the PC board mounted eight-position DIP switch module is turned **OFF**, turning a channel **OFF** will cause that channel's TS 2 channel status output to maintain State 1 (Normal Operation / Detector Channel OK). When DIP switch 2 is turned **ON**, turning a channel **OFF** will cause that channel's TS 2 channel status output to enter State 2 (Detector Channel Failure).

2.7 NOISE FILTER

DIP switch 3 on the eight-position PC board mounted DIP switch module controls the Noise Filter function. When the DIP switch is set to the **ON** position, the filter function is activated, and a time filter is added before the output signal is activated when a vehicle is in the loop detection area. It is strongly recommended that the Filter be **ON**

for most traffic control applications. The factory default setting of this feature is *ON* (Noise Filter On). *The setting of this feature affects the detector's response times. (See Section 3.4 for actual response times.)*

NOTE: Changing the position of the Noise Filter DIP switch will reset the detector

2.8 FAIL-SAFE / FAIL-SECURE

Fail-Safe or Fail-Secure mode of operation is selectable for each channel by using PC board mounted DIP switches. DIP switches 4, 5, 6, and 7 on the eight-position PC board mounted DIP switch module control channels 1, 2, 3, and 4. When the DIP switch corresponding to a given channel is in the *ON* position, that channel will operate in Fail-Safe mode.

During a loop failure condition, the state of the channel's output can be selected as Call in the Fail-Safe mode of operation or No Call in the Fail-Secure mode of operation. Fail-Safe operation during a loop failure is the standard operation for intersection control. Fail-Secure operation during a loop failure is typically used for incident detection systems for freeway management. The factory default setting of these four switches is *ON* (Fail-Safe operation).

NOTE: *Changing the Fail-Safe / Fail-Secure switch setting of an individual channel will reset that channel.*

Section 3 Specifications

3.1 PHYSICAL

WEIGHT: 6.0 oz (170 gm).

SIZE: Model Y-200 (double width faceplate) - 4.50 inches (11.43 cm) high x 2.00 inches (5.08 cm) wide x 6.88 inches (17.46 cm) long including connector (not including front handle). Model Y/2-200 (single width faceplate) - 4.50 inches (11.43 cm) high x 1.12 inches (2.84 cm) wide x 6.88 inches (17.46 cm) long including connector (not including front handle). Handle adds 1.00 inch (2.54 cm) to depth measurement.

OPERATING TEMPERATURE: -40° F to +180° F (-40° C to +82° C).

CIRCUIT BOARD: Printed circuit boards are 0.062 inch thick FR4 material with 2 oz. copper on both sides and plated through holes. Circuit board and components are conformal coated with polyurethane.

CONNECTOR: 2 x 22 contact edge card connector with 0.156 inch (0.396 cm) contact centers. Key slots located between B/2 & C/3, M/11 & N/12, and E/5 & F/6. See Section 3.6 for pin assignments.

3.2 ELECTRICAL

POWER: 10.8 to 30 VDC. 100 milliamps maximum.

LOOP INDUCTANCE RANGE: 20 to 2000 microhenries with a Q factor of 5 or greater.

LOOP INPUTS: Transformer isolated. The minimum capacitance added by the detector is 0.068 microfarad.

LIGHTNING PROTECTION: Meets and/or exceeds all applicable NEMA TS 2-1998 specifications for transient voltage protection. The detector can tolerate, without damage, a 10 microfarad capacitor charged to 2,000 volts being discharged directly into the loop input terminals, or a 10 microfarad capacitor charged to 2,000 volts being discharged between either loop terminal and earth ground.

RESET: Meets and/or exceeds NEMA TS 2-1998 detector specifications. Each detector channel can be manually reset by momentarily changing any switch position (except the frequency switches). The detector can also be reset by connecting a logic ground signal to Contact C of the card edge connector or the return of power after a power loss.

SOLID STATE OUTPUT RATING: Optically isolated. 30 VDC max. collector (drain) to emitter (source). 50 mA max. saturation current. 2 VDC max. transistor saturation voltage. The output is protected with a 33-volt Zener diode connected between the collector (drain) and emitter (source).

3.3 OPERATIONAL

DETECT / FAIL INDICATORS: The detector has one super bright, high intensity, two color (green / red) light emitting diode (LED) per channel to indicate a Call output and/or the status of any current or prior loop failure conditions. A continuous ON (green) state indicates a Call output. A continuous ON (red) state indicates that a current open loop failure condition or an inductance change condition of greater than +25% exists. This indication also generates a Call output if the channel is set to operate in Fail-Safe Mode. If set to operate in Fail-Secure Mode, a Call output is not generated. A one Hz (red) flash rate indicates that a current shorted loop failure condition or an inductance change condition of greater than -25% exists. This indication also generates a Call output if the channel is set to operate in Fail-Safe Mode. If set to operate in Fail-Secure Mode, a Call output is not generated. A flash rate of three 50 millisecond (red) pulses indicates a prior loop failure condition. A flash rate of three 50 millisecond (red) pulses followed by a single 750 millisecond (green) pulse indicates a prior loop failure condition and a current Call output (detect state).

If any channel has the audible detect feature activated, that channel's Detect / Fail LED will be illuminated in an orange state for any Call output condition.

Detect / Fail LED	Meaning
OFF	No Detect / No Loop Failure Condition (No Call Output)
Solid ON (Green)	Detect (Call Output)
Solid ON (Orange)	Audible Detect Signal Activated, Detect (Call Output)
Solid ON (Red)	Open Loop Failure Or Inductance change condition of greater than +25% exists
One Hz flash rate (Red) (50% Duty Cycle)	Shorted Loop Failure Or Inductance change condition of greater than -25% exists
Three 50 ms (Red) flashes per second	Loop Failure condition occurred but no longer exists
Three 50 ms (Red) flashes per second followed by a single 750 ms (Green) flash	Loop Failure condition occurred but no longer exists And Detect (Call Output)
Three 50 ms (Red) flashes per second followed by a single 750 ms (Orange) flash	Loop Failure condition occurred but no longer exists, Audible Detect Signal Activated, And Detect (Call Output)

RESPONSE TIME: Meets or exceeds NEMA TS 2-1998 response time specifications. Actual response times of either channel depend on the sensitivity level setting and Noise Filter selection of that channel. When the Noise Filter function is enabled (ON), response time is 120 ms \pm 40 ms for all sensitivity levels. When the Noise Filter function is disabled (OFF), response time varies and depends on the sensitivity level selected. See **Table: Sensitivity, $\Delta I/L$, & Typical Response Times** for actual response times.

SELF-TUNING: The detector automatically tunes and is operational within two seconds after application of power or after being reset. Full sensitivity and hold time requires 30 seconds of operation.

ENVIRONMENTAL & TRACKING: The detector is fully self-compensating for environmental changes and loop drift over the full temperature range and the entire loop inductance range.

GROUNDING LOOP OPERATION: The loop isolation transformer allows operation with poor quality loops (which may include one short to ground at a single point).

LOOP FEEDER LENGTH: Up to 5000 feet (1500m.) maximum with proper feeder cable and appropriate loops.

LOOP (FAIL) MONITOR: If the total inductance of the channel's loop input network goes out of the range specified for the detector, or rapidly changes by more than \pm 25%, the channel will immediately enter the programmed Fail-Safe or Fail-Secure mode of operation. The Fail-Safe mode of operation generates a continuous call during the loop failure. The Fail-Secure mode of operation does not generate a continuous call during the loop failure. The Detect / Fail LED will provide an indication to identify the type of loop failure condition that exists. A continuous ON (red) state indicates that a current open loop failure condition or an inductance change condition of greater than +25% exists. A one Hz (red) flash rate indicates that a current shorted loop failure condition or an inductance change condition of greater than -25% exists. This will continue as long as the loop fault exists. **However, if the detector is reset, or power is momentarily lost, the detector will return if the loop inductance is within the acceptable range. If any type of loop failure occurs in one (or more) loop(s) in a group of two or more loops wired in parallel, the detector will not respond with a Fail-Safe output following any type of reset. It is essential that multiple loops wired to a common detector channel always be wired in series to ensure Fail-Safe operation under all circumstances.** If the loop self-heals, the detector will resume operation in a normal manner except that the Detect / Fail LED will begin to flash at a rate of three 50 millisecond (red) flashes per second, thus providing an alert that the detector has experienced a prior loop failure condition. During this state, the Detect / Fail LED will also illuminate for 750 milliseconds (green) for a Call output. The Detect / Fail LED will continue this display pattern indicating the prior loop failure condition and/or detect state until the detector is manually reset or power is removed.

FAIL-SAFE OUTPUTS: Per NEMA TS 2-1998. A detection output (Call) is indicated by a conducting state. When operating in Fail-Safe mode, a channel's output defaults to a Call state for any loop failure condition on that channel. When operating in Fail-Secure mode, a channel's output defaults to a No Call state for any loop failure condition on that channel. In either Fail-Safe or Fail-secure mode, a channel's output defaults to a Call state upon loss of power.

CHANNEL STATUS OUTPUTS: Per NEMA TS 2-1998. Each channel has an output LED that communicates the status states of the channel as follows:

State	Output
Normal operation	Continuous Low or On State
Channel failure	Continuous High or Off State
Open loop	50 millisecond On time, 50 millisecond Off time
Shorted loop	50 millisecond On time, 100 millisecond Off time
Excessive inductance change (\pm 25%)	50 millisecond On time, 150 millisecond Off time

3.4 TABLE: SENSITIVIT -L/L, & TYPICAL RESPONSE TIMES

Sensitivity Level	Industry Reference	DIP Switch			-ΔL/L Threshold	Response Time	
		4	5	6		Noise Filter Off	Noise Filter On
0		OFF	OFF	OFF	OFF	-----	-----
1		ON	OFF	OFF	0.64%	17 ms ±5 ms	120 ms ±40 ms
2	Low	OFF	ON	OFF	0.32%	17 ms ±5 ms	120 ms ±40 ms
3		ON	ON	OFF	0.16%	35 ms ±10 ms	120 ms ±40 ms
4	Normal	OFF	OFF	ON	0.08%	50 ms ±15 ms	120 ms ±40 ms
5		ON	OFF	ON	0.04%	75 ms ±25 ms	120 ms ±40 ms
6	High	OFF	ON	ON	0.02%	120 ms ±40 ms	120 ms ±40 ms
7		ON	ON	ON	0.01%	120 ms ±40 ms	120 ms ±40 ms

NOTE: Entries in this table are based on the assumption that all channels are set to the same sensitivity. To approximate response time for a detector with the channels set to different sensitivities, look up the response time for each channel and divide it by four, then add these times together.

3.5 TABLES: DEFAULT SETTINGS

Front Panel Mounted DIP Switches

DIP Switch	Function	Setting	Position
1	Frequency	0	OFF
2			OFF
3	Presence / Pulse Mode	Presence	ON
4	Sensitivity	6	OFF
5			ON
6			ON

PC Board Mounted DIP Switches

DIP Switch	Function	Setting	Position
1	Test Mode	Off	OFF
2	TS 2 Channel Off Status	Off	OFF
3	Noise Filter	Filter On	ON
4	Channel 1 Fail-Safe / Fail-Secure	Fail-Safe	ON
5	Channel 2 Fail-Safe / Fail-Secure		ON
6	Channel 3 Fail-Safe / Fail-Secure		ON
7	Channel 4 Fail-Safe / Fail-Secure		ON
8	N/A	N/A	OFF

3.6 TABLE: PIN ASSIGNMENTS

Pin	Function
A	DC Common
B	DC +
C	Reset Input
D	Channel 1 Loop Input
E	Channel 1 Loop Input
F	Channel 1 Output, Collector (Drain)
H	Channel 1 Output, Emitter (Source)
J	Channel 2 Loop Input
K	Channel 2 Loop Input
L	Chassis Ground
M	No Connection
N	No Connection
P	Channel 3 Loop Input
R	Channel 3 Loop Input
S	Channel 3 Output, Collector (Drain)
T	Channel 3 Output, Emitter (Source)
U	Channel 4 Loop Input
V	Channel 4 Loop Input
W	Channel 2 Output, Collector (Drain)
X	Channel 2 Output, Emitter (Source)
Y	Channel 4 Output, Collector (Drain)
Z	Channel 4 Output, Emitter (Source)

Pin	Function
1	No Connection
2	No Connection
3	No Connection
4	Channel 1 Loop Input
5	Channel 1 Loop Input
6	No Connection
7	Channel 1 TS 2 Status Output
8	Channel 2 Loop Input
9	Channel 2 Loop Input
10	No Connection
11	No Connection
12	No Connection
13	Channel 3 Loop Input
14	Channel 3 Loop Input
15	No Connection
16	Channel 3 TS 2 Status Output
17	Channel 4 Loop Input
18	Channel 4 Loop Input
19	No Connection
20	Channel 2 TS 2 Status Output
21	No Connection
22	Channel 4 TS 2 Status Output

Section 4 User Interface

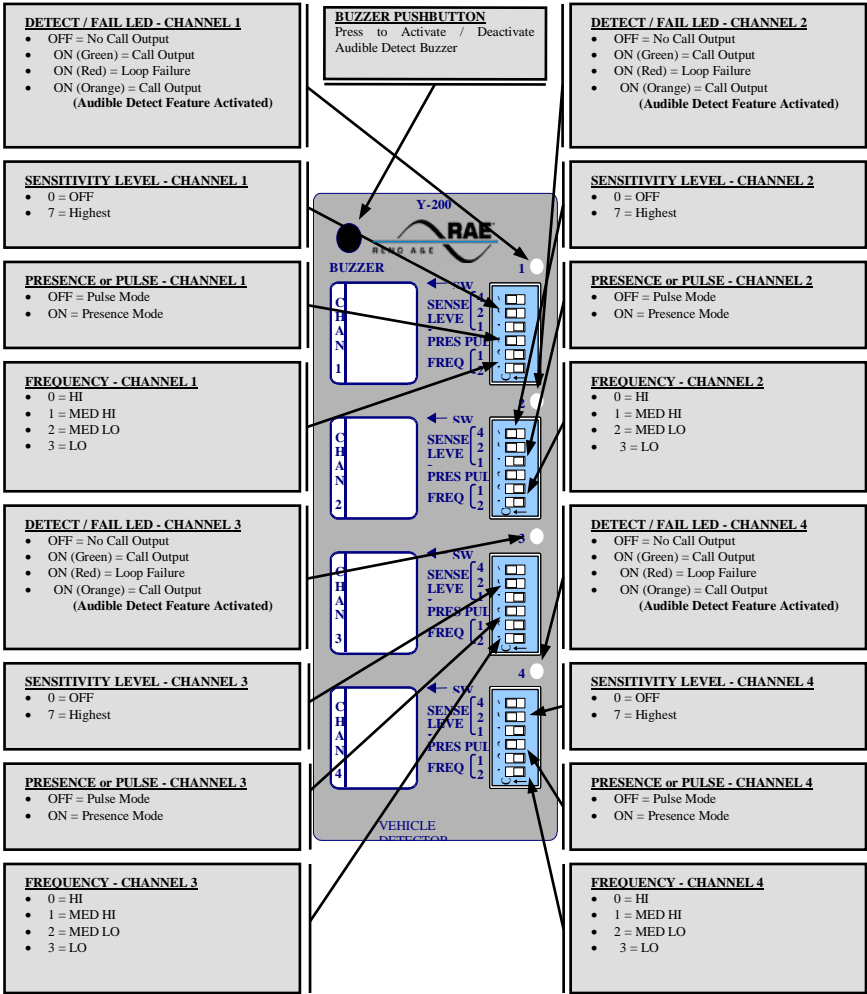

NOTE: There is an eight-position DIP switch module (S5) located near the center of the PC board. DIP switch 1 must be in the **OFF** position for the detector to function properly.

Section 5 Installation and Set-Up

Each channel has a front panel mounted six-position DIP switch module to control the operation of the channel. There is also an eight-position DIP switch module located near the center of the PC board. The various switches can be set before or after the detector card is inserted into a card rack wired with appropriate contact assignments. The **PRES PULSE** switches on the four, six-position DIP switch modules and the **FAIL-SAFE**, **FILTER**, and **100 MS** switches on the eight-position DIP switch module can be pre-selected for the desired modes of operation. The **SENSE LEVEL** and **FREQ** switches may require adjustment after the detector card has been inserted into the card rack. When the detector is inserted into the card rack, each channel will automatically tune to the loop circuit and begin operation within two seconds.

Ensure that DIP switch 1 on the eight-position DIP switch module (S5) located near the center of the PC board is set to the **OFF** position. This switch must be **OFF** for the detector to operate correctly. Plug the detector into an appropriately wired card rack receptacle and apply power.

5.1 FRONT PANEL PROGRAMMING DIP SWITCHES

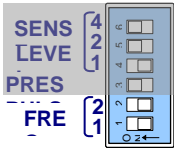

Frequency: The Model Y-200 detector sequentially activates each channel's loop circuit; so crosstalk between adjacent loops connected to different channels of the same detector is normally not a concern. Adjacent loops connected to different detectors may crosstalk. This may require changing the operating frequency of one of the loop circuits. If crosstalk is a problem, select another loop frequency for stable operation. Each channel of the Model Y-200 has four frequency selections that allow altering the resonant frequency of the loop circuit. The four frequency selections are selected with two switches marked 1 and 2 on the DIP switch module. The value (1 or 2) to the left of the DIP switch is assigned to the switch when the switch is **ON**. If the switch is **OFF**, the switch has a value of zero (0). By adding the switch **ON** and **OFF** values, the two switches can combine for values from 0 to 3 that indicate one of the four frequency selections. Use the following table as a reference for the switch selections and frequency settings. The factory default setting of these switches is switch 1 **OFF** and switch 2 **OFF** (High).

NOTE: After changing any frequency switch setting(s), it is necessary to reset the detector channel by momentarily changing one of the other switch positions.

Frequency	DIP Switch 1	DIP Switch 2	Switch Values
High *	OFF *	OFF *	0 + 0 = 0 *
Medium High	ON	OFF	1 + 0 = 1
Medium Low	OFF	ON	0 + 2 = 2
Low	ON	ON	1 + 2 = 3

* Factory default setting.

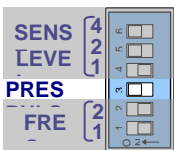

Presence / Pulse Output Mode: One of two output modes can be selected for each channel via DIP switch 3.

PRESENCE (PRES): When the switch is in the **ON** position, Presence Mode is selected. Presence Mode provides a call hold time of at least four minutes (regardless of vehicle size) and typically one to three hours for an automobile or truck. This is the factory default setting and the most common setting.

PULSE (PULS): When the switch is in the **OFF** position, Pulse Mode is selected. Pulse Mode will generate a single 125 millisecond pulse output for each vehicle entering the loop detection zone. Any vehicle remaining in the loop detection zone longer than two seconds will be tuned out providing full sensitivity for the vacant portion of the loop detection zone. Full sensitivity for the entire loop detection zone is recovered within one second following the departure of any vehicle that has occupied the loop detection zone longer than two seconds.

NOTE: Changing the setting of this switch will reset the channel.

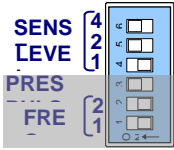

Sensitivity: Each detector channel has seven sensitivity levels plus OFF that are selected with three switches labeled 4, 5, and 6 on the DIP switch module. The value (1, 2, or 4) to the left of the DIP switch is assigned to the switch when the switch is **ON**. If the switch is **OFF**, the switch has a value of zero (0). By adding the switch **ON** and **OFF** values, the three switches will combine for values from 0 to 7 that indicate OFF or one of the seven sensitivity level selections. Choose the lowest sensitivity level that will consistently detect the smallest vehicle that must be detected. Do not use any sensitivity level higher than necessary. The following table shows the actual sensitivity for each combination of switch settings. The factory default setting of these switches is switch 4 **OFF**, switch 5 **ON**, and switch 6 **ON** (sensitivity level 6, $-\Delta L/L = 0.02\%$).

Sensitivity Level	Industry Reference	DIP Switch			Switch Values	- $\Delta L/L$ Threshold
		4	5	6		
0	Off	OFF	OFF	OFF	0 + 0 + 0 = 0	N/A
1		ON	OFF	OFF	1 + 0 + 0 = 1	0.64%
2	Low	OFF	ON	OFF	0 + 2 + 0 = 2	0.32%
3		ON	ON	OFF	1 + 2 + 0 = 3	0.16%
4	Normal	OFF	OFF	ON	0 + 0 + 4 = 4	0.08%
5		ON	OFF	ON	1 + 0 + 4 = 5	0.04%
6 *	High *	OFF *	ON *	ON *	0 + 2 + 4 = 6 *	0.02% *
7		ON	ON	ON	1 + 2 + 4 = 7	0.01%

* Factory default setting.

5.2 FRONT PANEL MOUNTED PUSHBUTTON – AUDIBLE DETECT SIGNAL (BUZZER)

The pushbutton on the front panel labeled **BUZZER** is used to enable an Audible Detect Signal. When this feature is enabled (on), an audible signal will be activated whenever the detection zone for the selected channel is occupied. The audible signal indicates actual occupancy of the loop detection zone. Only one channel can be

turned on at a time. Turning this feature on for one channel automatically turns it off for the other channels. To activate this feature, press the pushbutton. The first time the pushbutton is pressed, a short (50 millisecond) audible signal confirms the activation of the feature for Channel 1. The second time the pushbutton is pressed, two short (50 ms) audible signals confirm the activation of the feature for Channel 2. The third time the pushbutton is pressed, three short (50 ms) audible signals confirm the activation of the feature for Channel 3. The fourth time the pushbutton is pressed, four short (50 ms) audible signals confirm the activation of the feature for Channel 4. To deactivate this feature, press and hold the pushbutton for one second. A long (250 millisecond) audible signal confirms the deactivation of the feature.

NOTES: When operating in Pulse Mode, the audible detect signal will cease once a vehicle has occupied the detection zone for more than two seconds.

This feature is automatically disabled 15 minutes after activation or on loss of power.

5.3 PC BOARD MOUNTED PROGRAMMING DIP SWITCHES

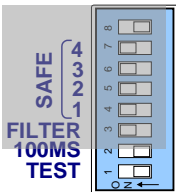

Test Mode: Test Mode uses the microcontroller to verify the proper operation of the entire detector's input and output circuitry including switches, LEDs, and outputs. Each channel's loop oscillator circuit is also checked to verify the correct frequency in each of the four frequency selections. Test mode is selected by means of DIP switch 1 on the eight-position DIP switch module located near the center of the PC board. Refer to Section 8.5 for a complete explanation of Test Mode operation. The factory default setting of this switch is **OFF** (Test Mode Off).

TS 2 Channel Off Status: The Y-200 detector's TS 2 channel status outputs conform to the status states specified in NEMA Standards TS 2-1998. When DIP switch 2 (labeled **100MS**) on the eight-position DIP switch module located near the center of the PC board is turned **OFF**, turning a channel **OFF** will cause that channel's TS 2 channel status output to maintain State 1 (Normal Operation / Detector Channel OK). When DIP switch 2 is turned **ON**, turning a channel **OFF** will cause that channel's TS 2 channel status output to enter State 2 (Detector Channel Failure). The factory default setting of this switch is **OFF**.

NOTE: The setting of this switch affects all four detector channels.

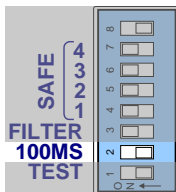

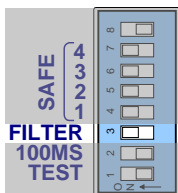

Noise Filter: DIP switch 3 on the eight-position DIP switch module located near the center of the PC board controls the Noise Filter function. When the DIP switch is set to the **ON** position, the filter function is activated, and a time filter is added before the output signal is activated when a vehicle is in the loop detection area. It is strongly recommended that the Filter be **ON** for most traffic control applications. The factory default setting of this feature is **ON** (Noise Filter On).

NOTE: The setting of this switch affects all four detector channels.

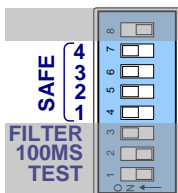

Fail-Safe / Fail-Secure: Fail-Safe or Fail-Secure mode of operation is selectable for each channel using DIP switches 4, 5, 6, and 7 on the eight-position DIP switch module located near the center of the PC board. DIP switch 4 controls channel 1, DIP switch 5 controls channel 2, DIP switch 6 controls channel 3, and DIP switch 7 controls channel 4. These switches set the default state of the channel's output when a loop failure condition exists on the loop network connected to the channel. One of two output states, shown in the table below, can be selected during a loop failure condition.

Operation	Detect / Fail LED	Output State
Fail-Safe	Solid ON (Red) or One Hz flash rate (Red)	Call
Fail-Secure	Solid ON (Red) or One Hz flash rate (Red)	No Call

When the switch is in the **ON** position, the Fail-Safe mode of operation is selected. Fail-Safe operation during a loop failure is the standard mode of operation for intersection control. When the switch is in the **OFF** position, the Fail-Secure mode of operation is selected. Fail-Secure operation during a loop failure is typically used in incident detection systems for freeway management. The factory default setting of these four switches is **ON** (Fail-Safe Mode).

NOTE: Changing the setting of any of these switches will reset the associated channel.

DIP Switch 8: DIP switch 8 is a spare. It has no function.

5.4 LOOP FAIL INDICATIONS

The Detect / Fail LED for each channel indicates loop failure problems according to the following table. The Detect / Fail LED is illuminated in a red state to provide an indication of either a current or prior out of tolerance (loop failure) condition. A continuous ON (red) state indicates that a current open loop failure condition or an inductance change condition of greater than +25% exists. A one Hz (red) flash rate indicates that a current shorted loop failure condition or an inductance change condition of greater than -25% exists. If the loop self heals, the channel will resume operation in a normal manner except that the Detect / Fail LED will begin to flash at a rate of three 50 millisecond (red) flashes per second, thus providing an alert that the channel has experienced a prior loop failure condition.

Detect / Fail LED	Meaning
OFF	No Loop Failure
Solid ON (Red)	Open Loop Failure or Inductance change condition of greater than +25% exists
One Hz flash rate (Red) (50% Duty Cycle)	Shorted Loop Failure or Inductance change condition of greater than -25% exists
Three 50 ms (Red) flashes per second	Loop Failure condition occurred but no longer exists

5.5 RESETTING THE DETECTOR

Changing the position of any of an individual channel's front panel mounted DIP switches (except the Frequency switches) resets the channel. When the detector is installed and operating, the most convenient method for resetting is to momentarily change the position of the **PRES / PULS** DIP switch and then return it to its original position. Changing the position of the individual channel's PC board mounted Fail-Safe / Fail-Secure DIP switch will also reset the channel. Changing the position of the PC board mounted **FILTER** or **TEST** DIP switch resets the detector. The detector can also be reset by connecting a logic ground signal to Contact C of the edge card connector or by the reapplication of power after a power loss.

Section 6 Block Diagram

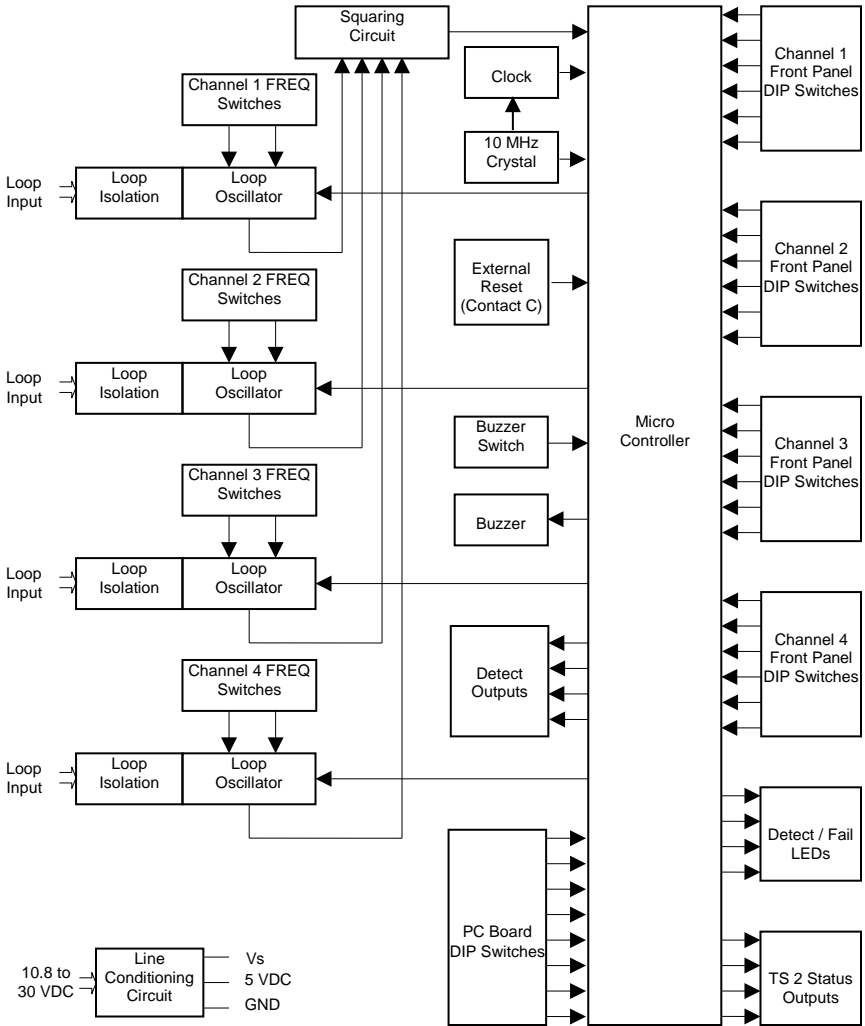

Section 7 Theory of Operation

The Reno A & E Model Y-200 Detector digitally measures changes in the resonant frequency of four independent parallel tuned resonant circuits (loop / lead-in) to determine if a vehicle has entered the detection zones. The detector applies an excitation voltage to each loop circuit resulting in the loops oscillating at its resonant frequency. The current flow in the loop wire creates magnetic fields around the loop wire. When a vehicle passes over the loop area, the conductive metal of the vehicle causes a loading of the loop's magnetic fields. The loading decreases the loop inductance, which causes the resonant frequency to increase. By continuously sampling the loop's resonant frequency, the magnitude and rate of change can be determined. If the frequency change exceeds a selectable threshold (set by the sensitivity settings), the detector will activate an output signal. If the rate of change is slow, typical of environmental drift, the detector will continuously track and compensate for the change. The detector also monitors the loop frequency for out of range conditions such as an opened or shorted loop circuit.

The detector scans the loop / lead-in circuit connected to each detector channel. The scanning method alternates the on and off cycle of each channel's loop circuit. Each channel's oscillator circuit supplies the excitation voltage that is coupled to the loop circuit by a loop isolation transformer. The transformer provides high common mode isolation between the loop and detector electronics, which allows the detector to operate on poor quality loops including a single short to ground. The transformer also limits the amount of static energy (lightning) that can transfer to the detector electronics. A spark gap transient suppression device is connected across the loop inputs to the isolation transformer. This device will dissipate static charges prior to their reaching the transformer. The loop input is also filtered for 60-cycle noise. A network of three capacitors is connected to the detector side of the isolation transformer. The capacitors can be switched in or out of the oscillator circuit to shift the frequency of the loop circuit, thus providing frequency separation between adjacent loops.

The sine wave from the loop circuit is squared for the microcontroller to digitally measure the period of several cycles. A high-speed clock sets a reference count for the period in a counter. If the frequency increases, the period is shorter and the period count decreases. By comparing the new count with the reference count, a percentage of change can be calculated that indirectly relates to the inductance change. If the magnitude of the change exceeds a selectable threshold (sensitivity setting), the detector activates the output device.

The rate of change is also monitored. Slow rates of change typical of environmental drift are tracked and automatically compensated for. If the total inductance of the loop input network goes out of the range specified for the detector, or rapidly changes by more than $\pm 25\%$, the channel will immediately enter the programmed Fail-Safe or Fail-Secure mode of operation. Fail-Safe operation generates a continuous call output in the Presence Mode or Pulse Mode. Fail-Secure operation does not generate a call during the loop failure. In both modes of operation, the Detect / Fail LED will turn ON (red) or flash (red) at a one Hz rate and remain ON or continue flashing as long as the loop failure condition exists. If the loop self-heals, the channel will resume operation in a normal manner; except the Detect / Fail LED will begin to flash at a rate of three red flashes per second, thus providing an alert of a prior Loop Fail condition. The Detect / Fail LED will continue indicating the last loop failure condition until the detector is manually reset or power is removed.

The detector is designed to operate from D.C. power sources providing either 12 VDC or 24 VDC. On-board regulators provide regulated voltages so that the detector can safely operate over the full input voltage range of 10.8 VDC to 30 VDC. The unit is also provided with an external reset capability. When Contact C of the edge card connector receives a logic ground signal for a minimum of 30 microseconds, both channels of the detector are immediately reset. Changing any front panel switch (except the frequency switches) resets the associated channel.

The operating parameters of each detector channel are established by DIP switch settings on DIP switch modules located on the front panel or PC board. Operating parameters that can be selected on the front panel are Sensitivity, Presence / Pulse Mode, and Loop Frequency. Operating parameters that can be selected on the PC board are Test Mode, TS 2 Channel Off Status, Noise Filter, and Fail-Safe / Fail-Secure Operation. A front panel mounted pushbutton is used for activation of an audible detect signal. The loop frequency switches are directly connected to the tuning capacitors in the loop oscillator circuits. The settings of the remaining switches are strobed into the microprocessor. The microprocessor provides eight output signals: a separate output line for each channel and a separate fail status line for each channel. Each output line drives a fail-safe optically isolated transistor. Solid state output devices provide faster turn on and turn off times, thus giving more accurate information when the detector is used in speed and/or occupancy applications. The output signals are connected to four, dual color (green / red), front panel mounted Detect / Fail LEDs. Each LED corresponds to an individual detector channel. The Detect / Fail LEDs are normally extinguished when there are no detect outputs, the loops are in tolerance, and there have been no previous failure conditions. A Detect / Fail LED will be steady ON (green) when a current detect output state exists. A Detect / Fail LED will be steady ON (red) when a current open loop failure or an inductance change condition of more than 25% exists. A Detect / Fail LED will flash at a one Hz rate (red) when a current shorted loop failure or an inductance change condition of less than 25% exists. When a Detect / Fail LED flashes at a rate of three 50 millisecond flashes per second (red), it is an indication that the loop is currently in tolerance, but the detector channel has previously experienced an out of tolerance condition. If a current detect output state exists and a detector channel has previously experienced an out of tolerance condition, the corresponding Detect / Fail LED will flash at a rate of three 50 millisecond flashes per second (red) followed by a single 750 millisecond flash (green). Either of these prior failure Detect / Fail LED flashing conditions will be reset whenever the detector is reset, the channel is reset, or power is interrupted.

The detector offers a choice of operation in either Fail-Safe or Fail-Secure Mode. Fail-Safe operation is the proper choice for intersection control applications where the detector should output a vehicle detect condition in the event of either a loop failure or power failure condition. Fail-Secure operation is the proper choice for freeway management applications where it is undesirable for the detector to output a vehicle detect condition for a loop failure condition. A vehicle detect condition on a freeway would be considered a stalled vehicle. When the detector is operated in the Fail-Secure Mode, the detector offers a faster response time than it does when operated in the Fail-Safe Mode. Slightly slower response times in the Fail-Safe Mode allow more filtering, hence providing more noise immunity for intersection control applications.

The Reno A & E Model Y-200 detector is designed and manufactured using the latest available technology in electronic design and manufacturing, thus providing the highest possible performance and reliability. Once properly installed a Reno A & E loop detector will provide years of trouble free operation.

8.2 TROUBLESHOOTING LOOP FAIL PROBLEMS

Is one of the four front panel LEDs showing a Loop Failure indication (ON Red or one Hz flash rate Red)?

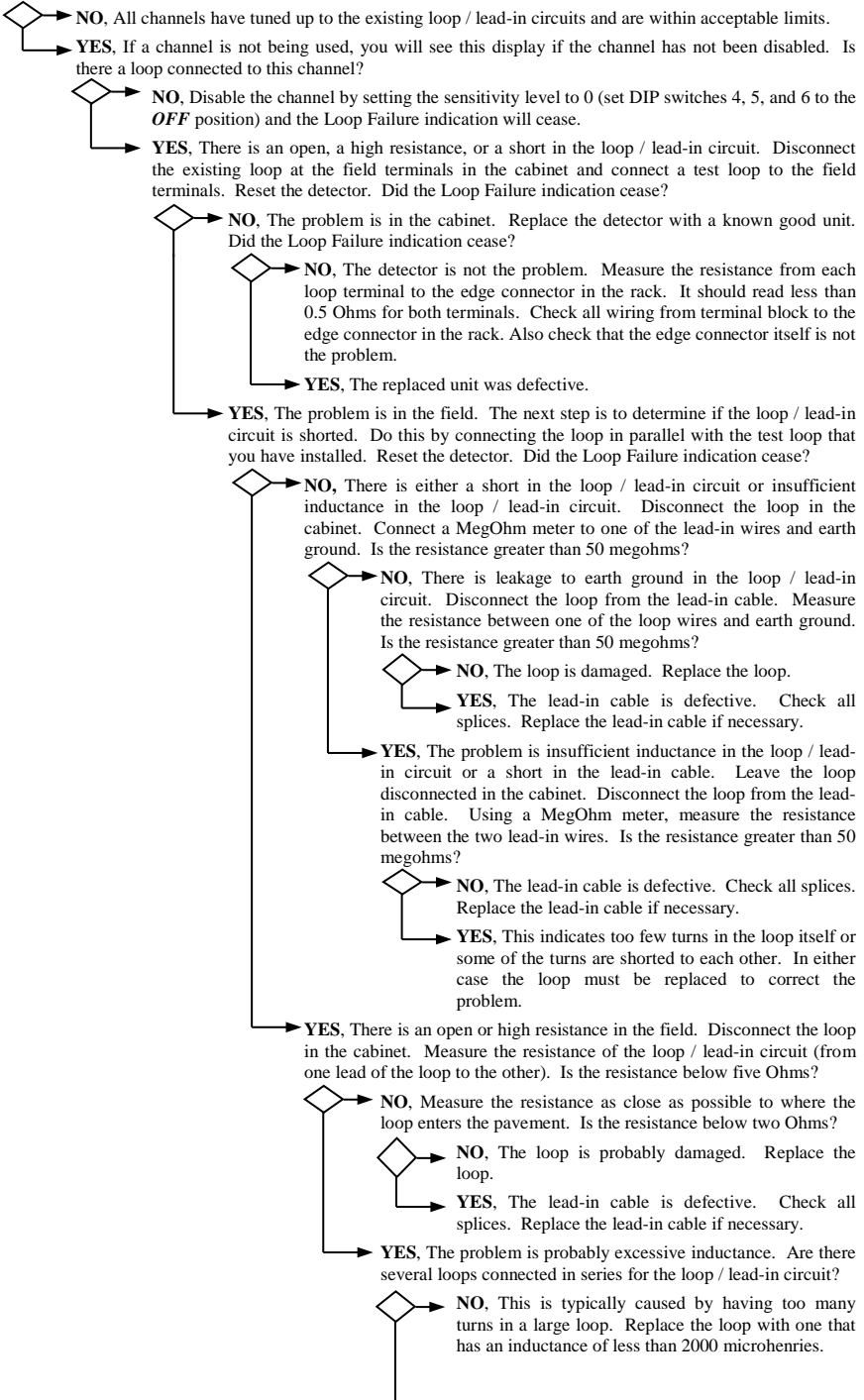

- **YES**. If possible, connecting each loop to its own detector is preferred. Or try a parallel wiring arrangement for the loops if separate detection channels are not possible.

8.3 TROUBLESHOOTING INTERMITTENT LOOP FAIL PROBLEMS

Intermittent Loop Fail problems tend to be associated with bad splices in the loop / lead-in circuit, shorts in the loop / lead-in circuit, shorts to earth ground in the loop / lead-in circuit, or loose connections or bad solder joints in the signal cabinet. If you have any splices that are not soldered and sealed with an adhesive heat shrink or epoxy resin, replace the splice with one that is. Using a MegOhm meter, measure the resistance from one of the loop wires to earth ground. It should be greater than 50 megaohms. Inspect the loop. Look for exposed wires or debris pressed into the saw cut. Tighten all screw terminals in the signal cabinet that the loop circuit uses. Check solder joints in the loop circuit, especially on the rack itself. Disconnect and reconnect any connector used in the loop circuit and check for loose pins and sockets in these connectors. If your cabinet has lightning or surge suppression devices on the loop inputs in the cabinet, remove or replace them. Check for places in the field where the loop wire or lead-in cable may be pinched or chaffed. Look for wires pinched under junction box covers and where the wire enters conduit, especially where the loop wire leaves the saw cut and enters a conduit. After checking all of the above items, you could swap out the detector but this type of failure is rarely ever related to the detector.

8.4 TROUBLESHOOTING INTERMITTENT DETECTOR LOCK UPS

Problems of this type tend to be difficult to isolate due to the many possible causes and the short duration of the symptom (usually less than 30 minutes). If the problem occurs more frequently in the morning or when raining, suspect a short to earth ground in the loop / lead-in circuit. This can usually be verified by testing with a MegOhm meter but not always. Vibration can also be a possible cause. Loop wires may be moving slightly in a conduit due to vibrations from truck traffic. Utility lids in the street near the loop may also be a source of problems. Ensure that lids near a loop are bolted down so that they cannot move. Check that each set of loop wires is twisted together in any pull boxes and that lengths are not excessive. Inspect the loop. Look for exposed wires or debris pressed into the saw cut. Check for places in the field where the loop wire or lead-in cable may be pinched or chaffed. Look for wires pinched under junction box covers and where the wire enters a conduit, especially where the loop wire leaves the saw cut and enters a conduit. **If your cabinet has lightning or surge suppression devices on the loop inputs in the cabinet, remove or replace them.** If you have any splices that are not soldered and sealed with an adhesive heat shrink or epoxy resin, replace the splice with one that is. Solder all crimp connections in the loop circuit. Tighten all screw terminals in the signal cabinet that the loop circuit uses. Check solder joints in the loop circuit, especially on the harness itself. Disconnect and reconnect any connector used in the loop circuit and check for loose pins and sockets in these connectors.

8.5 TEST MODE OPERATION

Test Mode uses the microcontroller to verify the proper operation of the detector's controls and indicators (switches and LEDs). Each channel's loop oscillator circuit is also checked to verify the correct frequency in each of the four frequency selections. The frequency portion of the test requires the detector to be connected to a 100 microhenry loop. If an inductance value other than 100 microhenries is used, the frequency test results will be invalid.

NOTE: *The test procedures outlined below should not be performed in an operational traffic signal cabinet.*

Test Procedure (PC Board Mounted DIP Switches)

- STEP 1.** Remove power from the detector.
- STEP 2.** Set all front panel Channel 1 Programming DIP switches (S1) to the **OFF** position.
- STEP 3.** Set all front panel Channel 2 Programming DIP switches (S2) to the **OFF** position.
- STEP 4.** Set all front panel Channel 3 Programming DIP switches (S3) to the **OFF** position.
- STEP 5.** Set all front panel Channel 4 Programming DIP switches (S4) to the **OFF** position.
- STEP 6.** Set all PC board mounted DIP switches (S5) to the **OFF** position.
- STEP 7.** Set the **TEST** switch (switch 1 on the PC board mounted DIP switch module, S5) to the **ON** position. Insert the detector into a suitable test fixture and apply power. All of the detector's LED indicators should be OFF, all of the test box's detect outputs should be ON, and the Channel 4 TS 2 status output should be ON. Turn the **TEST** switch to the **OFF** position. All the LED indicators should remain OFF, all detect outputs should remain ON, and the Channel 4 TS 2 status output should be OFF. **Note:** *To test the frequency range the channel must be connected to a 100 microhenry loop.* The other tests may be performed with loops within the range of 20 to 2000 microhenries.

STEP 8. Individually, turn ON each switch of the PC board mounted DIP switch module (S5). Turn OFF each switch after verifying the results indicated in the chart below:

Switch Label	DIP Switch	LED Indications and Outputs
N/A	8	N/A
SAFE 4	7	Channel 2 Test Box Output OFF
SAFE 3	6	Channel 3 Test Box Output OFF
SAFE 2	5	Channel 4 Test Box Output OFF
SAFE 1	4	Channel 1 Test Box TS 2 Status Output ON
FILTER	3	Channel 2 Test Box TS 2 Status Output ON
100MS	2	Channel 3 Test Box TS 2 Status Output ON
TEST	1	Channel 4 Test Box TS 2 Status Output ON

STEP 9. Remove power from the detector.

Test Procedure (Programming DIP Switches)

STEP 1. Remove power from the detector.

STEP 2. Set all front panel Channel 1 Programming DIP switches (S1) to the **OFF** position.

STEP 3. Set all front panel Channel 2 Programming DIP switches (S2) to the **OFF** position.

STEP 4. Set all front panel Channel 3 Programming DIP switches (S3) to the **OFF** position.

STEP 5. Set all front panel Channel 4 Programming DIP switches (S4) to the **OFF** position.

STEP 6. Set all PC board mounted DIP switches (S5) to the **OFF** position.

STEP 7. Set the **TEST** switch (switch 1 on the PC board mounted DIP switch module, S5) to the **ON** position. Insert the detector into a suitable test fixture and apply power. All of the detector's LED indicators should be OFF, all of the test box's detect outputs should be ON, and the Channel 4 TS 2 status output should be ON. Turn the **TEST** switch to the **OFF** position. All the LED indicators should remain OFF, all detect outputs should remain ON, and the Channel 4 TS 2 status output should be OFF. *Note: To test the frequency range the channel must be connected to a 100 microhenry loop.* The other tests may be performed with loops within the range of 20 to 2000 microhenries.

STEP 8. Individually, turn ON switches 6, 5, 4, and 3 of the Channel 1 Programming DIP switch module (S1). Turn OFF each switch after verifying the results indicated in the table below.

Switch Label	DIP Switch	LED Indications and Outputs
SENSE LEVEL 4	6	Channel 1 Detect / Fail LED Illuminated - GREEN
SENSE LEVEL 2	5	Channel 1 Detect / Fail LED Illuminated - RED
SENSE LEVEL 1	4	Channel 1 Detect / Fail LED Illuminated - GREEN
PRES PULS	3	Channel 1 Detect / Fail LED Illuminated - RED

STEP 9. Individually, turn ON switches 6, 5, 4, and 3 of the Channel 2 Programming DIP switch module (S2). Turn OFF each switch after verifying the results of the detector's LEDs indicated in the chart below.

Switch Label	DIP Switch	LED Indications and Outputs
SENSE LEVEL 4	6	Channel 2 Detect / Fail LED Illuminated - GREEN
SENSE LEVEL 2	5	Channel 2 Detect / Fail LED Illuminated - RED
SENSE LEVEL 1	4	Channel 2 Detect / Fail LED Illuminated - GREEN
PRES PULS	3	Channel 2 Detect / Fail LED Illuminated - RED

STEP 10. Individually, turn ON switches 6, 5, 4, and 3 of the Channel 3 Programming DIP switch module (S3). Turn OFF each switch after verifying the results of the detector's LEDs indicated in the chart below.

Switch Label	DIP Switch	LED Indications and Outputs
SENSE LEVEL 4	6	Channel 3 Detect / Fail LED Illuminated - GREEN
SENSE LEVEL 2	5	Channel 3 Detect / Fail LED Illuminated - RED
SENSE LEVEL 1	4	Channel 3 Detect / Fail LED Illuminated - GREEN
PRES PULS	3	Channel 3 Detect / Fail LED Illuminated - RED

STEP 11. Individually, turn ON switches 6, 5, 4, and 3 of the Channel 4 Programming DIP switch module (S4). Turn OFF each switch after verifying the results of the detector's LEDs indicated in the chart below.

Switch Label	DIP Switch	LED Indications and Outputs
SENSE LEVEL 4	6	Channel 4 Detect / Fail LED Illuminated - GREEN
SENSE LEVEL 2	5	Channel 4 Detect / Fail LED Illuminated - RED
SENSE LEVEL 1	4	Channel 4 Detect / Fail LED Illuminated - GREEN
PRES PULS	3	Channel 4 Detect / Fail LED Illuminated - RED

STEP 12. Remove power from the detector.

Test Procedure (Frequency DIP Switches)

- STEP 1.** Remove power from the detector.
- STEP 2.** Set all front panel Channel 1 Programming DIP switches (S1) to the **OFF** position.
- STEP 3.** Set all front panel Channel 2 Programming DIP switches (S2) to the **OFF** position.
- STEP 4.** Set all front panel Channel 3 Programming DIP switches (S3) to the **OFF** position.
- STEP 5.** Set all front panel Channel 4 Programming DIP switches (S4) to the **OFF** position.
- STEP 6.** Set all PC board mounted DIP switches (S5) to the **OFF** position.
- STEP 7.** Set the **TEST** switch (switch 1 on the PC board mounted DIP switch module, S5) to the **ON** position. Insert the detector into a suitable test fixture and apply power. All of the detector's LED indicators should be OFF, all of the test box's detect outputs should be ON, and the Channel 4 TS 2 status output should be ON. Turn the **TEST** switch to the **OFF** position. All the LED indicators should remain OFF, all detect outputs should remain ON, and the Channel 4 TS 2 status output should be OFF.
- STEP 8.** **NOTE: To test the frequency range, each channel must be connected to a 100 microhenry loop.** Set the switches and verify the results as indicated in the chart below:

	DIP Switch 1 (FREQ 2)	DIP Switch 2 (FREQ 1)	LED Indications
CH 1	OFF	OFF	N/A
	ON	OFF	Channel 1 Detect / Fail LED Flash - RED
	ON	ON	Channel 1 Detect / Fail LED Flash - GREEN / RED
	OFF	ON	Channel 1 Detect / Fail LED Flash - GREEN
	OFF	OFF	Channel 1 Detect / Fail LED OFF
CH 2	OFF	OFF	N/A
	ON	OFF	Channel 2 Detect / Fail LED Flash - RED
	ON	ON	Channel 2 Detect / Fail LED Flash - GREEN / RED
	OFF	ON	Channel 2 Detect / Fail LED Flash - GREEN
	OFF	OFF	Channel 2 Detect / Fail LED OFF
CH 3	OFF	OFF	N/A
	ON	OFF	Channel 3 Detect / Fail LED Flash - RED
	ON	ON	Channel 3 Detect / Fail LED Flash - GREEN / RED
	OFF	ON	Channel 3 Detect / Fail LED Flash - GREEN
	OFF	OFF	Channel 3 Detect / Fail LED OFF
CH 4	OFF	OFF	N/A
	ON	OFF	Channel 4 Detect / Fail LED Flash - RED
	ON	ON	Channel 4 Detect / Fail LED Flash - GREEN / RED
	OFF	ON	Channel 4 Detect / Fail LED Flash - GREEN
	OFF	OFF	Channel 4 Detect / Fail LED OFF

STEP 9. Remove power from the detector.

An LED indication different than the ones described for each DIP switch setting indicates the loop frequency is out of tolerance. Verify that the loop test coil has an inductance of 100 microhenries. If the test loop measures 100 microhenries the detector module should be serviced.

Test Procedure (Buzzer)

- STEP 1.** Remove power from the detector.
- STEP 2.** Refer to the table in Section 3.5 and set all front panel programming DIP switches (S1, S2, S3, and S4) to their default positions.
- STEP 3.** Refer to the table in Section 3.6 and set all PC board mounted DIP switches (S5) to their default positions.
- STEP 4.** Insert the detector into a suitable test fixture and apply power. All the LED indicators should be OFF. *NOTE: To test the frequency range, the channel must be connected to a 100 microhenry loop.* The other tests may be performed with any loops within the range of 20 to 2000 microhenries.
- STEP 5.** Press the front panel mounted pushbutton labeled **BUZZER**. The buzzer should sound once (50 ms).
- STEP 6.** Perform the actions and verify the results indicated in the table below.

Action	LED Indications and Outputs
Input Call Channel 1	<ul style="list-style-type: none"> ● Channel 1 Detect / Fail LED Illuminated - ORANGE ● Buzzer Sounds
Remove Call Channel 1	<ul style="list-style-type: none"> ● Channel 1 Detect / Fail LED Illuminated - ORANGE ● Buzzer OFF

- STEP 7.** Press the front panel mounted pushbutton labeled **BUZZER**. The buzzer should sound twice (50 ms).
- STEP 8.** Perform the actions and verify the results indicated in the table below.

Action	LED Indications and Outputs
Input Call Channel 1	<ul style="list-style-type: none"> ● Channel 2 Detect / Fail LED Illuminated - ORANGE ● Buzzer Sounds
Remove Call Channel 1	<ul style="list-style-type: none"> ● Channel 2 Detect / Fail LED Illuminated - ORANGE ● Buzzer OFF

- STEP 9.** Press the front panel mounted pushbutton labeled **BUZZER**. The buzzer should sound three times (50 ms).
- STEP 10.** Perform the actions and verify the results indicated in the table below.

Action	LED Indications and Outputs
Input Call Channel 1	<ul style="list-style-type: none"> ● Channel 3 Detect / Fail LED Illuminated - ORANGE ● Buzzer Sounds
Remove Call Channel 1	<ul style="list-style-type: none"> ● Channel 3 Detect / Fail LED Illuminated - ORANGE ● Buzzer OFF

- STEP 11.** Press the front panel mounted pushbutton labeled **BUZZER**. The buzzer should sound four times (50 ms).
- STEP 12.** Perform the actions and verify the results indicated in the table below.

Action	LED Indications and Outputs
Input Call Channel 1	<ul style="list-style-type: none"> ● Channel 4 Detect / Fail LED Illuminated - ORANGE ● Buzzer Sounds
Remove Call Channel 1	<ul style="list-style-type: none"> ● Channel 4 Detect / Fail LED Illuminated - ORANGE ● Buzzer OFF

- STEP 13.** Press the front panel mounted switch labeled **BUZZER**. The buzzer should sound once (250 ms).
- STEP 14.** Remove power from the detector.

Test Procedure (Reset)

- STEP 1.** Remove power from the detector.
- STEP 2.** Refer to the table in Section 3.5 and set all front panel programming DIP switches (S1, S2, S3, and S4) to their default positions.
- STEP 3.** Refer to the table in Section 3.6 and set all PC board mounted DIP switches (S5) to their default positions.
- STEP 4.** Insert the detector into a suitable test fixture and apply power. All the LED indicators should be OFF. **NOTE: To test the frequency range, the channel must be connected to a 100 microhenry loop.** The other tests may be performed with any loops within the range of 20 to 2000 microhenries.
- STEP 5.** Perform the actions and verify the results indicated in the table below.
NOTE: Unless otherwise noted, references to switches, buttons, or inputs in the table correspond to labels on test equipment supplied by Reno A & E.

Switch / Button / Input	Action	LED Indications and Outputs
Channel 1 OPEN LOOP Pushbutton	Press and Hold	<ul style="list-style-type: none"> ● Detector Channel 1 Detect / Fail LED Illuminated - RED ● Detector Channel 1 Output ON ● Test Box Channel 1 Detect LED ON ● Test Box Channel 1 TS 2 Status LED Flash
Channel 1 OPEN LOOP Pushbutton	Release	<ul style="list-style-type: none"> ● Detector Channel 1 Detect / Fail LED Flash - RED (Three 50 ms Flashes per Second) ● Detector Channel 1 Output OFF ● Test Box Channel 1 Detect LED OFF ● Test Box Channel 1 TS 2 Status LED ON *
RESET Pushbutton	Press and Release	<ul style="list-style-type: none"> ● Detector Channel 1 Detect / Fail LED OFF ● Test Box Channel 1 TS 2 Status LED ON
Channel 2 OPEN LOOP Pushbutton	Press and Hold	<ul style="list-style-type: none"> ● Detector Channel 2 Detect / Fail LED Illuminated - RED ● Detector Channel 2 Output ON ● Test Box Channel 2 Detect LED ON ● Test Box Channel 2 TS 2 Status LED Flash
Channel 2 OPEN LOOP Pushbutton	Release	<ul style="list-style-type: none"> ● Detector Channel 2 Detect / Fail LED Flash - RED (Three 50 ms Flashes per Second) ● Detector Channel 2 Output OFF ● Test Box Channel 2 Detect LED OFF ● Test Box Channel 2 TS 2 Status LED ON *
RESET Pushbutton	Press and Release	<ul style="list-style-type: none"> ● Detector Channel 1 Detect / Fail LED OFF ● Test Box Channel 1 TS 2 Status LED ON
Channel 3 OPEN LOOP Pushbutton	Press and Hold	<ul style="list-style-type: none"> ● Detector Channel 3 Detect / Fail LED Illuminated - RED ● Detector Channel 3 Output ON ● Test Box Channel 3 Detect LED ON ● Test Box Channel 3 TS 2 Status LED Flash
Channel 3 OPEN LOOP Pushbutton	Release	<ul style="list-style-type: none"> ● Detector Channel 3 Detect / Fail LED Flash - RED (Three 50 ms Flashes per Second) ● Detector Channel 3 Output OFF ● Test Box Channel 3 Detect LED OFF ● Test Box Channel 3 TS 2 Status LED ON *
RESET Pushbutton	Press and Release	<ul style="list-style-type: none"> ● Detector Channel 3 Detect / Fail LED OFF ● Test Box Channel 3 TS 2 Status LED ON
Channel 4 OPEN LOOP Pushbutton	Press and Hold	<ul style="list-style-type: none"> ● Detector Channel 4 Detect / Fail LED Illuminated - RED ● Detector Channel 4 Output ON ● Test Box Channel 4 Detect LED ON ● Test Box Channel 4 TS 2 Status LED Flash
Channel 4 OPEN LOOP Pushbutton	Release	<ul style="list-style-type: none"> ● Detector Channel 4 Detect / Fail LED Flash - RED (Three 50 ms Flashes per Second) ● Detector Channel 4 Output OFF ● Test Box Channel 4 Detect LED OFF ● Test Box Channel 4 TS 2 Status LED ON *

Switch / Button / Input	Action	LED Indications and Outputs
RESET Pushbutton	Press and Release	<ul style="list-style-type: none"> ● Detector Channel 4 Detect / Fail LED OFF ● Test Box Channel 4 TS 2 Status LED ON

* **NOTE:** The TS 2 Status LED may continue flashing for up to five (5) seconds after the **OPEN LOOP** button is released.

STEP 6. Remove power from the detector.

8.6 THINGS TO KNOW ABOUT LOOPS

Always use a wire with cross-linked Polyethylene insulation (insulation type XLPE) for loop wire.

Typical sensing height is $\frac{2}{3}$ of the shortest leg of a loop. Therefore, a 6' x 6' loop will have a detection height of 4'.

The inductance of a conventional four-sided loop can be estimated using the formula:

$$L = P \times (T^2 + T) / 4$$

Where: L = Loop Inductance in microhenries
P = Loop Perimeter in feet
T = Number of Turns of Wire.

Therefore, a 6' by 6' loop with 3 turns would have an inductance of:

$$\begin{aligned} L &= (6 + 6 + 6 + 6) \times (3^2 + 3) / 4 \\ L &= 24 \times (9 + 3) / 4 \\ L &= 24 \times 12 / 4 \\ L &= 24 \times 3 \\ L &= 72 \text{ microhenries.} \end{aligned}$$

The inductance of a Quadrupole™ loop can be estimated using the formula:

$$L = [P \times (T^2 + T) / 4] + [CL \times (T^2 + T) / 4]$$

Where: L = Loop Inductance in microhenries
P = Loop Perimeter in feet
T = Number of Turns of Wire
CL = Length of Center Leg in feet.

Therefore, a 6' by 50' loop with a 2-4-2 configuration would have an inductance of:

$$\begin{aligned} L &= [(6 + 50 + 6 + 50) \times (2^2 + 2) / 4] + [50 \times (4^2 + 4) / 4] \\ L &= [112 \times (4 + 2) / 4] + [50 \times (16 + 4) / 4] \\ L &= (112 \times 6 / 4) + (50 \times 20 / 4) \\ L &= (112 \times 1.5) + (50 \times 5) \\ L &= 168 + 250 \\ L &= 418 \text{ microhenries.} \end{aligned}$$

Loop Feeder cable typically adds 0.22 microhenries of inductance per foot of cable.

Total inductance of loops connected in series:

$$L_{\text{TOTAL}} = L_1 + L_2 + L_3 + \dots + L_N.$$

Total inductance of loops connected in parallel:

$$L_{\text{TOTAL}} = 1 / [(1 / L_1) + (1 / L_2) + (1 / L_3) + \dots + (1 / L_N)].$$